

# Modicon M340 automation platform

Catalogue

September 2014



# How can you fit a 6000-page catalog in your pocket ?

Schneider Electric provides you with the complete set of industrial automation catalogs all on a handy USB key for PC or in an application for tablets



## Digi-Cat, a handy USB key for PC



- > Convenient to carry
- > Always up-to-date
- > Environmentally friendly
- > Easy-to-share format



Contact your local representative to get your own Digi-Cat



## e-Library, the app for tablets

If you have an iPad®:

- > Go to the App Store and search for e-Library
- > or scan the QR code



If you have an Android tablet:

- > Go to the Google Play Store™ and search for eLibrary
- > or scan the QR code



# General contents

Processor modules .....	1
Communication.....	2
Ruggedized Modicon M340 modules.....	3
Services .....	4



---

- Compatibility guide* ..... page 1/2
- **General presentation**..... page 1/6
- **Processor modules** ..... page 1/10
- Selection guide* ..... page 1/8
- **Presentation**..... page 1/10
- **Description**..... page 1/10
- **Memory structure** ..... page 1/12
- Memory cards ..... page 1/12
- Protecting the application ..... page 1/12
- Modifying the program in online mode ..... page 1/12
- **References** ..... page 1/13
- **Ruggedized modules** ..... page 3/1



# Modicon X80 I/O platform

Product compatibility according to the network architecture

Product type	Reference	Local rack Modicon M340		EIO Quantum drop with Modicon X80 EIO drop with CRA drop adaptor type	
		Single-rack or multi-rack	"standard" BMXCRA31200	"performance" BMXCRA31210	

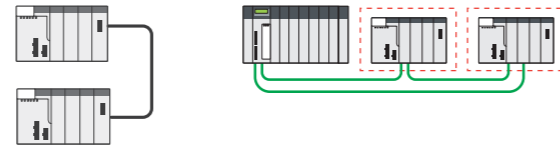

Application-specific modules	Module	Reference	Local rack Modicon M340	EIO Quantum drop with Modicon X80 EIO drop with CRA drop adaptor type
Application-specific modules	SSI encoder	BMXEAE0300/BMXEAE0300H	Compatible	Compatible
	Counter	BMXEHC0200/BMXEHC0200H	Compatible	Compatible
		BMXEHC0800/BMXEHC0800H	Compatible	Compatible
	Time stamping	BMXERT1604T	Compatible	Compatible
	PTO (Pulse Train Output)	BMXMSP0200	Compatible	Compatible
Communication modules	Weighing	PMESWT0100	Compatible	Compatible
	Ethernet	BMXNOC0401	Compatible	Compatible
		BMENOC03*1	Compatible	Compatible
		BMXNOE0100/BMXNOE0100H	Compatible	Compatible
		BMXNOE0110/BMXNOE0110H	Compatible	Compatible
	Serial link	BMXNOM0200/BMXNOM0200H	Compatible	Compatible
	RTU	BMXNOR0200H	Compatible	Compatible
	AS-Interface	BMXEIA0100	Compatible	Compatible
	Optical fibre	BMXNRP0200	Compatible	Compatible
		BMXNRP0201	Compatible	Compatible
	Wi-Fi	PMXNOW0300	Compatible	Compatible
Communication heads	BMXCRA31200	Compatible	Compatible	
	BMXCRA31210/BMXCRA31210C	Compatible	Compatible	
	BMECRA31210/BMECRA31210C	Compatible	Compatible	
	BMXPRA0100	Compatible	Compatible	
CPUs	M340	BMXP341000/BMXP341000H	Compatible	Compatible
		BMXP342000	Compatible	Compatible
		BMXP342010	Compatible	Compatible
		BMXP3420102	Compatible	Compatible
		BMXP342020H	Compatible	Compatible
		BMXP3420302/BMXP3420302H	Compatible	Compatible
		M580	BMEP581020/BMEP581020H	Compatible
	BMEP582020/BMEP582020H		Compatible	Compatible
	BMEP582040/BMEP582040H		Compatible	Compatible
	BMEP583020		Compatible	Compatible
	BMEP583040		Compatible	Compatible
	BMEP584020		Compatible	Compatible
	BMEP584040		Compatible	Compatible

Compatible Not compatible

Local rack Modicon M580		M580 EIO drop with X-bus BMXXBP backplane and CRA drop adaptor type		M580 EIO drop with Ethernet + X-bus BMEXP backplane and CRA drop adaptor	Ethernet Modbus TCP DIO drop with PRA connected to a Quantum/Premium/M580/M340 platform
X-bus BMXXBP rack	Ethernet + X-bus BMEXP rack	"standard" BMXCRA31200	"performance" BMXCRA31210	BMECRA31210	BMXPRA0100

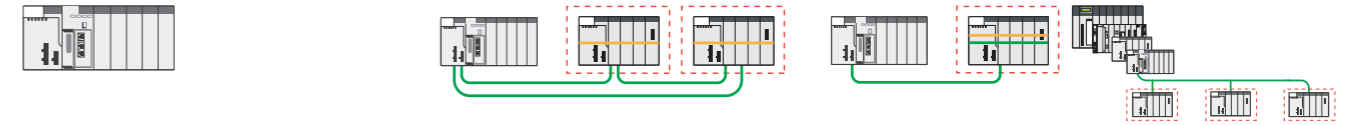

Application-specific modules	Module	Reference	Local rack Modicon M580	M580 EIO drop with X-bus BMXXBP backplane and CRA drop adaptor type	M580 EIO drop with Ethernet + X-bus BMEXP backplane and CRA drop adaptor	Ethernet Modbus TCP DIO drop with PRA connected to a Quantum/Premium/M580/M340 platform
Application-specific modules	SSI encoder	BMXEAE0300/BMXEAE0300H	Compatible	Compatible	Compatible	Compatible
Application-specific modules	Counter	BMXEHC0200/BMXEHC0200H	Compatible	Compatible	Compatible	Compatible
Application-specific modules	Counter	BMXEHC0800/BMXEHC0800H	Compatible	Compatible	Compatible	Compatible
Application-specific modules	Time stamping	BMXERT1604T	Compatible	Compatible	Compatible	Compatible
Application-specific modules	PTO (Pulse Train Output)	BMXMSP0200	Compatible	Compatible	Compatible	Compatible
Application-specific modules	Weighing	PMESWT0100	Compatible	Compatible	Compatible	Compatible
Communication modules	Ethernet	BMXNOC0401	Compatible	Compatible	Compatible	Compatible
Communication modules	Ethernet	BMENOC03*1	Compatible	Compatible	Compatible	Compatible
Communication modules	Ethernet	BMXNOE0100/BMXNOE0100H	Compatible	Compatible	Compatible	Compatible
Communication modules	Ethernet	BMXNOE0110/BMXNOE0110H	Compatible	Compatible	Compatible	Compatible
Communication modules	Serial link	BMXNOM0200/BMXNOM0200H	Compatible	Compatible	Compatible	Compatible
Communication modules	RTU	BMXNOR0200H	Compatible	Compatible	Compatible	Compatible
Communication modules	AS-Interface	BMXEIA0100	Compatible	Compatible	Compatible	Compatible
Communication modules	Optical fibre	BMXNRP0200	Compatible	Compatible	Compatible	Compatible
Communication modules	Optical fibre	BMXNRP0201	Compatible	Compatible	Compatible	Compatible
Communication modules	Wi-Fi	PMXNOW0300	Compatible	Compatible	Compatible	Compatible
Communication heads		BMXCRA31200	Compatible	Compatible	Compatible	Compatible
Communication heads		BMXCRA31210/BMXCRA31210C	Compatible	Compatible	Compatible	Compatible
Communication heads		BMECRA31210/BMECRA31210C	Compatible	Compatible	Compatible	Compatible
Communication heads		BMXPRA0100	Compatible	Compatible	Compatible	Compatible
CPUs	M340	BMXP341000/BMXP341000H	Compatible	Compatible	Compatible	Compatible
CPUs	M340	BMXP342000	Compatible	Compatible	Compatible	Compatible
CPUs	M340	BMXP342010	Compatible	Compatible	Compatible	Compatible
CPUs	M340	BMXP3420102	Compatible	Compatible	Compatible	Compatible
CPUs	M340	BMXP342020H	Compatible	Compatible	Compatible	Compatible
CPUs	M340	BMXP3420302/BMXP3420302H	Compatible	Compatible	Compatible	Compatible
CPUs	M580	BMEP581020/BMEP581020H	Compatible	Compatible	Compatible	Compatible
CPUs	M580	BMEP582020/BMEP582020H	Compatible	Compatible	Compatible	Compatible
CPUs	M580	BMEP582040/BMEP582040H	Compatible	Compatible	Compatible	Compatible
CPUs	M580	BMEP583020	Compatible	Compatible	Compatible	Compatible
CPUs	M580	BMEP583040	Compatible	Compatible	Compatible	Compatible
CPUs	M580	BMEP584020	Compatible	Compatible	Compatible	Compatible
CPUs	M580	BMEP584040	Compatible	Compatible	Compatible	Compatible

# Modicon M340 automation platform

## Composition

1



Modicon M340 automation platform comprising:  
 - BMXP34 type processors,  
 - A single-rack or multi-rack Modicon X80 I/O platform,  
 - Additional dedicated modules.

### Presentation

The Modicon M340 automation platform comprises:

- 1 BMXP34 dedicated processors
- 2 A Modicon X80 I/O platform, in a single-rack or multi-rack configuration
- 3 Additional modules for various applications (application-specific, Ethernet communication, etc.)

### Modicon M340 processors

Seven processor models comprising 1 Standard model (**BMXP341000**) and 6 Performance models (**BMXP3420●●●** or **BMXP3420●●●CL**) with different memory capacities, processing speeds, number of I/O and number and type of communication ports.

Depending on the model, they offer a maximum (non-cumulative) of:

- 512 to 1024 discrete I/O
- 128 to 256 analog I/O
- 20 to 36 application-specific channels (1) (process counter, motion control and serial link, or RTU)
- 0 to 3 Ethernet Modbus/TCP or Ethernet/IP networks (with or without integrated port and 2 network modules maximum)
- 4 "Full Extended master" AS-Interface V3 actuator/sensor buses, profile M4.0

Depending on the model, Modicon M340 processors include:

- A 10BASE-T/100BASE-TX Ethernet Modbus/TCP port
- A CANopen machine and installation bus port
- A Modbus or Character mode serial link port

Each processor has a USB TER port (for connecting a programming terminal or a Magelis GTO, GTW, STU/STO, etc. HMI terminal) (2).

It is supplied with a memory card (3) that enables:

- Backing up the application (program, symbols and constants)
- Activating a standard Web server for the Transparent Ready class B10 integrated Ethernet port (depending on the model)

Depending on the model, this memory card can be replaced by another type of memory card (to be ordered separately) that supports:

- Backing up the application and activation of the standard Web server (same as other card)
- An 8 MB or 128 MB storage area, depending on the option card, for storing additional data organized in a file system (directories and sub-directories)

### Modicon X80 I/O platform and additional modules (4)

The "Modicon X80 I/O" platform, which can be used "In Rack" and/or in a remote I/O (RIO) drop depending on the type of automation platform (Modicon M340, Quantum, etc.), comprises the following elements:

- Racks with 4, 6, 8 or 12 slots (2a)
- Power supply modules,  $\bar{\square}$  or  $\sim$  (2b)
- Discrete and analog I/O modules (2c)
- RTU (*Remote Terminal Unit*), serial link, AS-Interface, etc. communication modules (2d)

Additional dedicated modules for the Modicon M340 automation platform that can be used on "Modicon X80 I/O" are also available:

- Application-specific
- Ethernet (Modbus/TCP, Ethernet/IP) communication module

External modules, such as Modbus Plus, Profibus DP/PA communication as well as modules offered as part of CAPP (Collaboration Automation Partner Program), are also available.

### Treatment for severe environments

Using the "ruggedized" modules enables the Modicon M340 automation platform to be used in severe environments or at operating temperatures from  $-25^{\circ}\text{C}/-13^{\circ}\text{F}$  to  $+70^{\circ}\text{C}/158^{\circ}\text{F}$ . See pages 3/2 to 3/3.

(1) Maximum number of application-specific channels per station. Only the application-specific channels actually configured in the Unity application count.

(2) For details of the Magelis offer please visit our website [www.schneider-electric.com](http://www.schneider-electric.com).

(3) With the exception of 2 models supplied without memory card (see page 1/13).

(4) For further information, please consult our "Modicon X80 I/O platform" catalog available on our website [www.schneider-electric.com](http://www.schneider-electric.com).



# Modicon M340 automation platform

## Software configuration and multi-rack configuration



Unity Pro

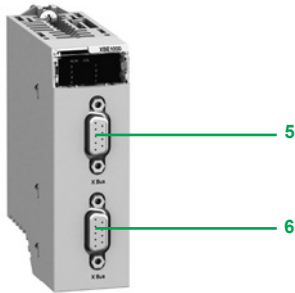
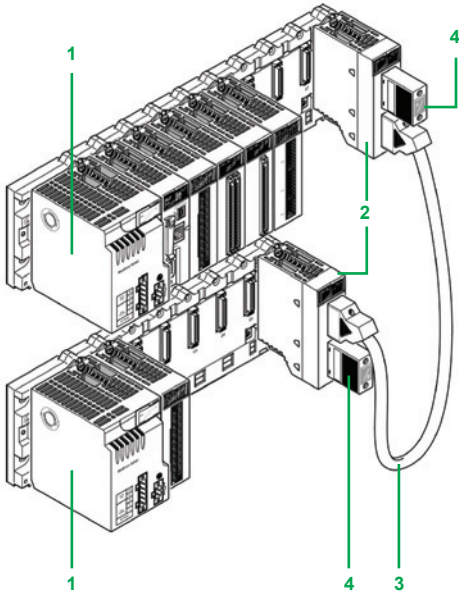

Rack expansion module  
BMXXBE1000



Line terminator  
TSXTLYEX

### Presentation (continued)

#### Design and setup of Modicon M340 applications

Setting up of the Modicon M340 automation platform processors requires the use one of the following software packages:

- Unity Pro Small programming software
- Unity Pro Medium, Large or Extra Large programming software or identical to that used to set up Modicon Premium and Modicon Quantum automation platforms
- Optionally, depending on requirements, Unity EFB toolkit software for developing EF and EFB function block libraries in C language

The function block software libraries provide Modicon M340 processors with the processing capability required to meet the specialized requirements within the motion control with multiple independent axis functions domain (MFB "Motion Function Blocks" library). The axes are controlled by Altivar 312/71 variable speed drives or Lexium 32 servo drives connected on the CANopen machine bus.

**Note:** Compatibility of BMXP3420102/20302 processors with the Unity Pro software version. BMXP3420102/20302 processors with integrated CANopen bus are compatible with Unity Pro version ≥ 4.1. Both these processors can be used to customize configuration of the device Boot Up procedure compatible with all CANopen third-party products.

### Composition of a multi-rack configuration

Multi-rack configurations are made up of standard BMXXBP●●00 racks. They comprise:

- 2 racks maximum for a station with BMXP341000 processor
- 4 racks maximum for a station with BMXP3420●●● or BMXP3420●●●CL processor

Each rack is equipped with:

- 1 A BMXCPS●●●●● power supply
- A BMXXBE1000 expansion rack module. This module, inserted in the right-hand end of the rack (XBE slot) does not occupy rack slots 00...11 (4, 6, 8 or 12 slots are still available). For further information, please consult our "Modicon X80 I/O platform" catalog available on our website [www.schneider-electric.com](http://www.schneider-electric.com).

### X-bus

The racks, distributed on the X-bus, are connected to each other by X-bus extension cordsets 3 with a total length of 30 m/98.42 ft maximum.

The racks are connected in a daisy chain using BMXXBC●●0K (1) X-bus extension cordsets connected to the two 9-way SUB-D connectors 5 and 6 on the front panels of the BMXXBE1000 rack expansion modules 2.

### Line terminators 4

Both expansion modules at the ends of the daisy chain must have a line terminator 4 TSXTLYEX on the unused 9-way SUB-D connector.

**Note:** The processor module is always positioned in the rack at address 0. However, in an X-bus daisy chain, the order of the racks has no effect on operation; the order of the daisy chain could be, for example 0-1-2-3, 2-0-3-1, 3-1-2-0, etc.

### Cybersecurity

Schneider Electric has always taken care of the security of its systems. Security guidelines are available for our customers to ensure their systems are protected from attacks.

The Modicon M340 is a cyber-secure platform thanks to its advanced built-in cybersecurity features and robustness.

The Modicon M340 automation platform also offers the following features:

- Protection against unauthorized remote connections via an online editable Access Control List
- Protection against remote programming changes via a password
- Option to enable or disable HTTP or FTP services
- Integrity of Unity Pro executable files
- Unnecessary services disabled by default
- Security features enabled by default

(1) Extension cordsets BMXXBC●●0K in lengths of 0.8 m/2.62 ft, 1.5 m/4.92 ft, 3 m/9.84 ft, 5 m/16.40 ft or 12 m/39.37 ft with elbowed connectors or TSXCBY●08K in lengths of 1 m/3.28 ft, 3 m/9.84 ft, 5 m/16.40 ft or 12 m/39.37 ft, 18 m/59.05 ft ou 28 m/91.86 ft with straight connectors.

# Modicon M340 automation platform

## Modicon M340 processors

Type of Modicon M340 processor

Standard processor

Performance processors with or without memory card



<b>Racks</b>	Number of racks Max. number of slots (excluding power supply module)	2 (with 4, 6, 8 or 12 slots) 24	4 (with 4, 6, 8 or 12 slots) 48
<b>I/O</b>	In-rack discrete I/O (1)	512 channels (modules with 8, 16, 32 or 64 channels)	1024 channels (modules with 8, 16, 32 or 64 channels)
	In-rack I/O (1)	128 channels (modules with 2, 4, 6 or 8 channels)	256 channels (modules with 2, 4, 6 or 8 channels)
	Distributed I/O (limited depending on the type of medium)	- On Ethernet Modbus/TCP via network module (63 devices with I/O Scanning function) - On Modbus link (32 devices)	
<b>In-rack application-specific channels</b>	No. of channels (counter, motion control, serial link) Counter (1)	20 max.	36 max.
	Motion control (1)	BMXEHC0200 2-channel (60 kHz) or BMXEHC0800 8-channel (10 kHz) modules	
	Serial link (process or RTU) (1)	BMXMSP0200 2-channel (200 kHz) PTO ( <i>Pulse Train Output</i> ) modules for servo drives	
	Process control, programmable loops	-	
<b>Integrated communication ports</b>	Ethernet Modbus/TCP network	BMXNOM0200 2-channel module or BMXNOR0200H module with 1 RTU serial channel	
	CANopen master bus	Process control EFB library	
	Serial link (process or RTU)	-	
	USB port	1 in RTU/ASCII Modbus master/slave mode or in Character mode (non-isolated RS232/RS485, 0.3...38.4 Kbps)	
<b>Communication modules (1)</b>	Ethernet network Max. no. Type of module	2 BMXNOE0100/0110 or BMXNOC0401 network modules or BMXNOR0200H module with 1 Ethernet RTU channel	
	AS-Interface bus Max. no. Type of module	2	4 BMXEIA0100 master module
<b>Internal memory capacity</b>	Internal user RAM	2048 KB	4096 KB
	Program, constants and symbols	1792 KB	3584 KB
	Located/unlocated data	128 KB	256 KB
<b>Memory card capacity (on processor)</b>	Backup of program, constants and symbols	8 MB as standard	
	Hosting and display of user Web pages	(2)	
	File storage	-	8 or 128 MB (according to BMXRMS●●8MPF option card)
<b>Application structure</b>	Master task	1	
	Fast task	1	
	Event tasks	32	64
<b>No. of K instructions executed per ms</b>	100% Boolean	5.4 Kinstructions/ms	8.1 Kinstructions/ms
	65% Boolean + 35% fixed arithmetic	4.2 Kinstructions/ms	6.4 Kinstructions/ms
<b>Rack power supply</b>		24 V --- isolated, 24...48 V --- isolated or 100...240 V ~ power supply module	
<b>References</b>		<b>BMXP341000</b>	<b>BMXP342000</b>
<b>Page</b>		1/13	

(1) The maximum values for the number of discrete I/O, analog I/O, counter/motion control/serial link channels and the number of networks are not cumulative (they are limited by the maximum number of slots in the configuration, 1 rack: 11, 2 racks: 23, 3 racks: 35 and 4 racks: 47).  
 (2) User web pages with BMXNOE0110 Ethernet FactoryCast module (12 MB available).  
 (3) BMXP3420102/20102CL/20302/20302CL processors can be used to customize configuration of the device Boot Up procedure compatible with all CANopen third-party products. Requires Unity Pro software, version ≥ V4.1.

Performance processors with or without memory card (continued)



		4 (with 4, 6, 8 or 12 slots) 48		
		1024 channels (modules with 8, 16, 32 or 64 channels)		
		256 channels (modules with 2, 4, 6 or 8 channels)		
		- On CANopen bus (63 devices), - On Ethernet Modbus/TCP via network module (63 devices with I/O Scanning function), - On Modbus link (32 devices).		
		36 max.		
		BMXEHC0200 2-channel (60 kHz) or BMXEHC0800 8-channel (10 kHz) modules		
		BMXMSP0200 2-channel (200 kHz) PTO ( <i>Pulse Train Output</i> ) modules for servo drives		
		MFB (Motion Function Blocks) library (for drives or servo drives on CANopen bus)	-	MFB (Motion Function Blocks) library (for drives or servo drives on CANopen bus)
		BMXNOM0200 2-channel module or BMXNOR0200H module with 1 RTU serial channel		
		Process control EFB library		
		-	1 x 10BASE-T/100BASE-TX (Modbus/TCP, BOOTP/DHCP, FDR client, e-mail notification, class B10 standard web server)	
		1 (63 slaves, 50...1000 Kbps, class M20) (3)	-	1 (63 slaves, 50...1000 Kbps, class M20) (3)
		1 in RTU/ASCII Modbus master/slave mode or in Character mode (non-isolated RS232/RS485, 0.3...38.4 Kbps)		
		1 programming port (PC terminal) or HMI connection port		
		2		
		BMXNOE0100/0110 or BMXNOC0401 network modules or BMXNOR0200H module with 1 Ethernet RTU channel		
		4		
		BMXEIA0100 master module		
		4096 KB		
		3584 KB		
		256 KB		
		8 MB as standard	Supplied without card	8 MB as standard
		(2)		
		8 or 128 MB (according to BMXRMS●●8MPF option card)		
		1		
		1		
		64		
		8.1 Kinstructions/ms		
		6.4 Kinstructions/ms		
		24 V --- isolated, 24...48 V --- isolated or 100...240 V ~ power supply module		
		<b>BMXP3420102</b>	<b>BMXP3420102CL</b>	<b>BMXP342020</b>
			<b>BMXP3420302</b>	<b>BMXP3420302CL</b>
		1/13		

(1) The maximum values for the number of discrete I/O, analog I/O, counter/motion control/serial link channels and the number of networks are not cumulative (they are limited by the maximum number of slots in the configuration, 1 rack: 11, 2 racks: 23, 3 racks: 35 and 4 racks: 47).  
 (2) User web pages with BMXNOE0110 Ethernet FactoryCast module (12 MB available).  
 (3) BMXP3420102/20102CL/20302/20302CL processors can be used to customize configuration of the device Boot Up procedure compatible with all CANopen third-party products. Requires Unity Pro software, version ≥ V4.1.

1

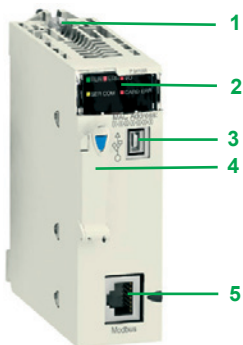

BMXP341000/2000

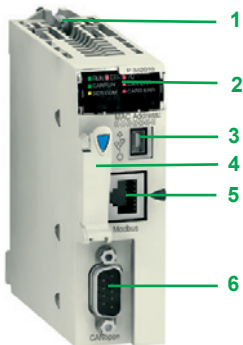

BMXP3420102/BMXP3420102CL

### Presentation

Dedicated processor modules BMXP34, which form part of a Modicon M340 automation platform, are available in two types:

- Standard type processor modules
- Performance type processor modules

The main differences between these 2 types of processor are:

- Their number of I/O (512 or 1024)
- Their memory capacity (2,048 or 4,096 KB)
- The type of communication ports integrated in each model

### Description of BMXP341000/2000/20102/20102CL processors

**BMXP341000/2000/20102/20102CL** Standard and Performance single-format processors have the following on the front panel:

- 1 Safety screw for locking the module in its slot (marked 0) in the rack.
- 2 A display block comprising 5 or 7 LEDs, depending on the model:
  - Run LED (green): processor in operation (program execution)
  - ERR LED (red): processor or system fault
  - I/O LED (red): I/O module fault
  - SER COM LED (yellow): activity on the Modbus serial link
  - CARD ERR LED (red): memory card missing or faulty
  - CAN RUN LED (green): integrated CANopen bus operational (**BMXP3420102** and **BMXP3420102CL** models only)
  - CAN ERR LED (red): integrated CANopen bus fault (**BMXP3420102** and **BMXP3420102CL** models only)
- 3 A mini B USB connector for a programming terminal (or Magelis GT/GTO/GK/GTW and STU/STO HMI terminal (1)).
- 4 A slot equipped with its Flash memory card (2) for backing up the application (an LED, located above this slot, indicates recognition of or access to the memory card).
- 5 An RJ45 connector for Modbus serial link or Character mode link (RS 232C/RS 485, 2-wire, non-isolated).

With, in addition, for **BMXP3420102** and **BMXP3420102CL** models:

- 6 A 9-way SUB-D connector for the integrated CANopen master bus.

(1) Magelis GT/GTO/GK/GTW and STU/STO graphic terminals with USB port and Vijeo Designer configuration software version  $\geq 4.5$ . For more detailed information, please refer to our website [www.schneider-electric.com](http://www.schneider-electric.com).

(2) Except for model BMXP3420102CL, which is supplied without memory card.

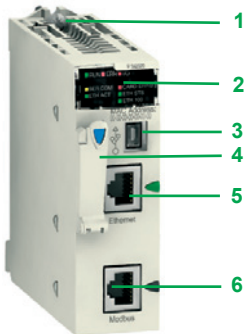

BMXP342020

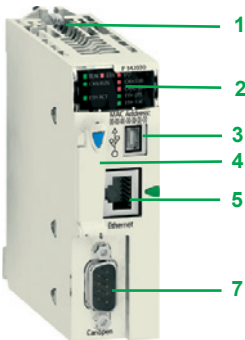

BMXP3420302/BMXP3420302CL

### Description of BMXP342020/20302/20302CL processors with integrated Ethernet Modbus/TCP port

**BMXP342020/20302/20302CL** Performance single-format processors have the following on the front panel:

- 1 Safety screw for locking the module in its slot (marked 0) in the rack.
- 2 A display block comprising 8 or 10 LEDs, depending on the model:
  - Run LED (green): processor in operation (program execution)
  - ERR LED (red): processor or system fault
  - I/O LED (red): I/O module fault
  - SER COM LED (yellow): activity on the Modbus serial link
  - CARD ERR LED (red): memory card missing or faulty
  - ETH ACT LED (green): activity on the Ethernet Modbus/TCP network
  - ETH STS LED (green): Ethernet Modbus/TCP network status
  - ETH 100 (red): Ethernet Modbus/TCP data rate (10 or 100 Mbps)
  - CAN RUN LED (green): integrated CANopen bus operational (**BMXP3420302** and **BMXP3420302CL** models only)
  - CAN ERR LED (red): integrated CANopen bus fault (**BMXP3420302** and **BMXP3420302CL** models only)
- 3 A mini B USB connector for a programming terminal (or Magelis GT/GTO/GK/GTW and STU/STO terminal (1)).
- 4 A slot equipped with its Flash memory card (2) for backing up the application (an LED, located above this slot, indicates recognition of or access to the memory card).
- 5 An RJ45 connector for connection to the 10BASE-T/100BASE-TX Ethernet Modbus/TCP network.

With, in addition, depending on the model:

- 6 **BMXP342020** processor: an RJ45 connector for the Modbus serial link or Character mode link (RS 232C/RS 485, 2-wire, non-isolated).
- 7 **BMXP3420302** and **BMXP3420302CL** processors: a 9-way SUB-D connector for the integrated CANopen master bus.

**On the back panel:** 2 rotary switches for selecting the IP address assignment method for the module.

#### USB terminal port

The USB port 3, offering a useful data rate of 12 Mbps, is compatible with Unity Pro programming software, the OPC Factory Server (OFS), and Magelis GT/GTO/GK/GTW and STU/STO HMI terminals (1).

All **BMXP34** processors can be connected to a USB bus comprising several peripheral devices. However:

- Only one processor can be connected to the USB bus
- No device on the USB bus can be controlled by the PLC (modem, printer)

(1) Magelis GT/GTO/GK/GTW and STU/STO graphic terminals with USB port and Vijeo Designer configuration software version  $\geq 4.5$ . For more detailed information, please refer to our website [www.schneider-electric.com](http://www.schneider-electric.com).

(2) Except for model **BMXP3420302CL**, which is supplied without memory card.

**Memory cards****BMXRMS008MP memory card (included as standard)**

Modicon M340 processors are supplied as standard (1) with an SD (*Secure Digital*) type Flash memory card, reference **BMXRMS008MP**. This card is intended for backing up the two memory areas on the processor module's internal RAM:

- Program, symbols and comments area, which contains the executable binary code and the IEC source code of the application program for the program part
- Constants area, which contains the constant data located by address.

The data is backed up automatically by duplication, when the PLC is turned off.

Likewise, the restoration of the data is transparent for the user, on return of power.

Capacity of the "backup area" on the memory card:

- 1792 KB for the **BMXP341000** Standard processor
- 3584 KB for the **BMXP342●●●●** Performance processors

**BMXP342020/20302/20302CL** processors with an integrated Ethernet port have an additional 2 MB memory area specifically for "Standard Web services" (Transparent Ready B10) (see page 2/16).

The **BMXRMS008MP** memory card is formatted by Schneider Electric and included with each processor. It is referenced as a replacement part.

**BMXRMS008MPF/128MPF optional memory cards**

**BMXP342●●●●** Performance processors can take a **BMXRMS008MPF** or **BMXRMS128MPF** optional memory card, with greater memory capacity, in place of the standard memory card. These cards also provide a "file storage area" with a maximum capacity of 8 MB (for the **BMXRMS008MPF** card) or 128 MB (for the **BMXRMS128MPF** card).

This "file storage area" enables:

- Any user-defined Word, Excel, PowerPoint or Acrobat Reader document to be received via FTP (for example, maintenance manuals, diagrams, etc.)
- Additional data to be stored via EFB user function blocks (for example: production data, manufacturing recipes, etc.)

Unity Pro programming software helps the application designer manage the structure and memory space occupation of the Modicon M340 automation platform.

**Protecting the application**

If necessary, it is possible to prohibit access to the application (in terms of reading and modifying the program) by only loading the executable code in the PLC.

Additionally, a memory protection bit, set in configuration mode, is also available to prevent any program modification (via the programming terminal or downloading).

From Unity Pro V5.0 on, the user has function blocks for protecting know-how by means of a signature that can be loaded and stored in the M340 processor module's Flash memory card (code not executed if the signature is not present).

**Program modification in online mode**

As with Modicon Premium and Quantum platforms (with Unity Pro software), the online program modification function is available on the Modicon M340 automation platform with the option of adding or modifying the program code and data in different places in the application in a single modification session (thus ensuring modification is homogenous and consistent with the controlled process).

A dedicated memory area of the application internal RAM authorizes these program modification or addition sessions while complying with the recommendation to structure the application program in several, reasonably-sized sections.

(1) With the exception of 2 models (see page 1/13).



BMXP341000



BMXP342000



BMXP3420102/20102CL  
BMXP3420302/20302CL



BMXP342020



BMXRMS008/128MPF



BMXXCAUSBH000

### Modicon M340 processors

I/O capacity	Max. no. of network and bus modules	Integrated communication ports	Compatibility with Unity Pro software	Memory card	Reference	Weight kg/lb
<b>Standard BMXP3410, 2 racks</b>						
<b>512 discrete I/O</b> <b>128 analog I/O</b> <b>20 application-specific channels</b> 2048 KB integrated (internal user memory)	2 Ethernet networks 2 AS-Interface buses	1 Modbus serial link	Version ≥ 3.0	Included	<b>BMXP341000</b>	0.200/ 0.441
<b>Performance BMXP3420, 4 racks</b>						
<b>1024 discrete I/O</b> <b>256 analog I/O</b> <b>36 application-specific channels</b> 4096 KB integrated (internal user memory)	2 Ethernet networks 4 AS-Interface buses	1 Modbus serial link	Version ≥ 3.0	Included	<b>BMXP342000</b>	0.200/ 0.441
		1 Modbus serial link 1 CANopen bus	Version ≥ 4.1	Included	<b>BMXP3420102 (1)</b>	0.210/ 0.463
				Not included (2)	<b>BMXP3420102CL (1)</b>	0.210/ 0.463
		1 Modbus serial link 1 Ethernet network	Version ≥ 3.0	Included	<b>BMXP342020</b>	0.205/ 0.452
		1 Ethernet network 1 CANopen bus	Version ≥ 4.1	Included	<b>BMXP3420302 (1)</b>	0.215/ 0.474
				Not included (2)	<b>BMXP3420302CL (1)</b>	0.215/ 0.474

### Memory cards

Description	Processor compatibility	Capacity	Reference	Weight kg/lb
<b>Flash Memory cards (optional)</b> (3)	BMXP342000 BMXP3420102 BMXP342020 BMXP3420302 BMXP3420102CL BMXP3420302CL	8 MB + 8 MB file storage	<b>BMXRMS008MPF</b>	0.002/ 0.004
		8 MB + 128 MB file storage	<b>BMXRMS128MPF</b>	0.002/ 0.004

### Separate parts

Description	Use		Length m/ft	Reference	Weight kg/lb
	From	To			
<b>Terminal port/USB cordsets</b>	Mini B USB port on the Modicon M340 processor	Type A USB port on:	1.8/	<b>BMXXCAUSBH018</b>	0.065/ 0.143
		- PC terminal, - Magelis XBT GT/GK/GTW, HMI GTW, HMI STU/STO HMI graphic terminal.	5.9/		
			4.5/ 14.76	<b>BMXXCAUSBH045</b>	0.110/ 0.243

### Replacement part

Description	Use	Processor compatibility	Reference	Weight kg/lb
<b>8 MB standard Flash memory card</b>	Included as standard with each processor. Used for: - Backing up the program, constants, symbols and data, - Activation of class B10 Web server.	BMXP341000 BMXP342000 BMXP342020 BMXP3420102/20302	<b>BMXRMS008MP</b>	0.002/ 0.004

(1) **BMXP3420102/20302** processors, combined with Unity Pro software version ≥ 4.1, can be used to customize configuration of the device Boot Up procedure compatible with all CANopen third-party products.

(2) These products are supplied without integrated memory card. The memory card must be ordered separately (see memory cards above).

(3) Memory cards for **BMXP342000** processors, to replace the standard memory card, used for:  
Backing up the program, constants, symbols and data  
Activation of class B10 Web server  
File storage



---

- Communication selection guide* ..... page 2/2
- **PlantStruxure Ethernet Architectures**
  - Logical communication architecture ..... page 2/8
  - Physical communication architecture ..... page 2/9
- Ethernet Modbus/TCP and EtherNet/IP networks**
  - **Ethernet Modbus/TCP communication services**
    - Presentation ..... page 2/10
    - Functions ..... page 2/11
  - **Web services**
    - Standard Web services ..... page 2/16
    - FactoryCast Web services ..... page 2/17
    - Web Designer configuration software ..... page 2/18
    - SOAP/XML Web services ..... page 2/19
  - **Processors with integrated Ethernet Modbus/TCP port**
    - Presentation, description, references ..... page 2/20
  - **Ethernet Modbus/TCP network modules**
    - Presentation, description, references ..... page 2/21
  - **Modbus/TCP and EtherNet/IP network module**
    - Presentation, functions, description ..... page 2/22
    - References ..... page 2/23
- Selection guide for web servers and gateways* ..... page 2/24
- Modbus Plus Proxy module**
  - Presentation ..... page 2/26
  - References ..... page 2/27
- Profibus DP V1 and Profibus PA buses**
  - Presentation ..... page 2/28
  - References ..... page 2/29
- CANopen machine and installation bus**
  - Presentation ..... page 2/30
  - Connectable devices ..... page 2/31
  - Description, references ..... page 2/32
  - Connections ..... page 2/33
  - Cabling system ..... page 2/34
- Modbus and Character mode serial links**
  - Presentation, description ..... page 2/38
  - Complementary characteristics, references ..... page 2/39



# Modicon M340 automation platform

Communication, integrated ports and modules

Applications		Ethernet communication																
Type of device		Processors with integrated Modbus/TCP port	Ethernet modules															
																		
Network protocols		<b>Ethernet Modbus/TCP</b>																
Structure		10BASE-T/100BASE-TX																
Physical interface		RJ45																
Type of connector		CSMA-CD																
Access method		10/100 Mbps																
Data rate		Double twisted pair copper cable, category CAT 5E Optical fibre via ConneXium cabling system																
Medium		-																
Configuration		-																
Maximum number of devices		1																
Max. length		100 m/328.08 ft (copper cable), 4000 m/13,123.32 ft (multi-mode optical fibre), 32,500 m/106,627 ft (single-mode optical fibre)																
Number of modules of the same type per station		2 Ethernet or RTU modules per station with any BMXP34 processor																
Standard services		Modbus/TCP messaging																
Transparent Ready conformity class		B10      B30      C30																
Embedded Web server services		Rack Viewer PLC diagnostics, Data Editor access to PLC data and variables																
Standard services		-																
Configurable services		Alarm Viewer and Graphic Data Editor Hosting and display of user Web pages (14 MB)																
Transparent Ready communication services		-																
I/O Scanning service		Yes																
Global Data service		Yes																
NTP time synchronization		Yes (module version ≥ 2.0)																
FDR service		Yes (client)																
SMTP e-mail notification service		Yes, via EF function block Unity Pro ≥ 4.0																
SOAP/XML Web service		-																
SNMP network management service		-																
RSTP redundancy service		Yes																
QoS (Quality of Service) service		-																
RTU communication services		-																
Master or Slave configuration		-																
Time and date stamped data exchange		-																
RTU time synchronization		-																
Management and buffering of time and date stamped events		-																
Automatic transfer of time and date stamped events to the Master/SCADA		-																
Data Logging service		-																
Compatibility with processor		Standard and Performance (see page 1/8)																
Processor or module references depending on other type of integrated port		<table border="1"> <thead> <tr> <th></th> <th>BMXNOE100</th> <th>BMXNOE110</th> </tr> </thead> <tbody> <tr> <td>No other integrated port</td> <td></td> <td></td> </tr> <tr> <td>Serial link</td> <td>BMXP342020</td> <td></td> </tr> <tr> <td>Ethernet Modbus/TCP</td> <td></td> <td></td> </tr> <tr> <td>CANopen</td> <td>BMXP3420302/ BMXP3420302CL</td> <td></td> </tr> </tbody> </table>			BMXNOE100	BMXNOE110	No other integrated port			Serial link	BMXP342020		Ethernet Modbus/TCP			CANopen	BMXP3420302/ BMXP3420302CL	
	BMXNOE100	BMXNOE110																
No other integrated port																		
Serial link	BMXP342020																	
Ethernet Modbus/TCP																		
CANopen	BMXP3420302/ BMXP3420302CL																	
Page		2/20      2/21																

Ethernet communication		RTU communication																					
Ethernet modules		RTU module																					
																							
Network protocols		<b>EtherNet/IP and Modbus/TCP</b>																					
Structure		10BASE-T/100BASE-TX																					
Physical interface		Four RJ45 connectors (2 connectors for a ring topology)																					
Type of connector		CSMA-CD																					
Access method		10/100 Mbps																					
Data rate		Double twisted pair copper cable, category CAT 5E, optical fibre via ConneXium cabling system																					
Medium		-																					
Configuration		-																					
Maximum number of devices		128 (EtherNet/IP or Modbus/TCP)																					
Max. length		100 m/328.08 ft (copper cable), 4000 m/13,123.32 ft (multi-mode optical fibre), 32,500 m/106,627 ft (single-mode optical fibre)																					
Number of modules of the same type per station		2 Ethernet or RTU modules per station with any BMXP34 processor																					
Standard services		EtherNet/IP and Modbus/TCP messaging																					
Transparent Ready conformity class		B30																					
Embedded Web server services		Rack Viewer PLC diagnostics, Data Editor access to PLC data and variables																					
Standard services		-																					
Configurable services		Hosting and display of user Web pages																					
Transparent Ready communication services		-																					
I/O Scanning service		-																					
Global Data service		-																					
NTP time synchronization		Yes																					
FDR service		Yes (client/server)																					
SMTP e-mail notification service		Yes (client)																					
SOAP/XML Web service		-																					
SNMP network management service		-																					
RSTP redundancy service		Yes																					
QoS (Quality of Service) service		-																					
RTU communication services		-																					
Master or Slave configuration		-																					
Time and date stamped data exchange		-																					
RTU time synchronization		-																					
Management and buffering of time and date stamped events		-																					
Automatic transfer of time and date stamped events to the Master/SCADA		-																					
Data Logging service		-																					
Compatibility with processor		Standard and Performance (see page 1/8)																					
Processor or module references depending on other type of integrated port		<table border="1"> <thead> <tr> <th></th> <th>BMXNOC0401</th> <th>BMXNOR0200H</th> <th>BMXNOR0200H</th> </tr> </thead> <tbody> <tr> <td>No other integrated port</td> <td></td> <td></td> <td></td> </tr> <tr> <td>Serial link</td> <td></td> <td></td> <td></td> </tr> <tr> <td>Ethernet Modbus/TCP</td> <td></td> <td></td> <td></td> </tr> <tr> <td>CANopen</td> <td></td> <td></td> <td></td> </tr> </tbody> </table>			BMXNOC0401	BMXNOR0200H	BMXNOR0200H	No other integrated port				Serial link				Ethernet Modbus/TCP				CANopen			
	BMXNOC0401	BMXNOR0200H	BMXNOR0200H																				
No other integrated port																							
Serial link																							
Ethernet Modbus/TCP																							
CANopen																							
Page		2/23      For further information, please consult our "Modicon X80 I/O platform" catalog available on our website <a href="http://www.schneider-electric.com">www.schneider-electric.com</a> .																					

# Modicon M340 automation platform

Communication, integrated ports and modules

Applications
Type of device

CANopen communication
Processors with integrated CANopen port

AS-Interface communication
AS-Interface actuator/sensor bus module



Serial link communication	
Processors with integrated serial link	2-channel serial link module



Network protocols

Structure	Physical interface
	Type of connector
	Access method
	Data rate

Medium

Configuration	Maximum number of devices
	Max. length
	Number of links of the same type per station

Standard services	
Conformity class	
SMTP service notification by e-mail	
Compatibility with processor	

Type of processor or module depending on other integrated port	None
	Serial link
	Ethernet Modbus/TCP
	CANopen

Page	2/32
------	------

◀ CANopen

ISO 11898 (9-way SUB-D connector)	
9-way SUB-D	
CSMA/CA (multiple access)	
20 Kbps...1 Mbps depending on distance	
Double shielded twisted pair copper cable	
63 depending on the devices connected	
20 m/65.62 ft (1 Mbps)...2500 m/8202.08 ft (20 Kbps)	
1	
PDO implicit exchange (application data) SDO explicit exchange (service data)	
Class M20	
–	Yes, via EF function block Unity Pro ≥ 4.0
–	

BMXP3420102/ BMXP3420102CL	
	BMXP3420302/ BMXP3420302CL

2/32
------

◀ AS-Interface

AS-Interface V3 standard	
3-way SUB-D	
Master/slave	
167 Kbps	
Two-wire AS-Interface cable	
62 slaves	
100 m/328.08 ft, 500 m/1640.42 ft max. with 2 repeaters	
1	
Transparent exchanges with the sensors/actuators	
M4 profile	
–	
Standard and Performance (see page 1/8)	

BMXEIA0100
------------

Consult our "Modicon X80 I/O platform" catalog available on our website [www.schneider-electric.com](http://www.schneider-electric.com).

◀ Modbus and Character mode

Non-isolated RS 232, 4-wire Non-isolated RS 485, 2-wire	Non-isolated RS 232, 8-wire Isolated RS 485, 2-wire
RJ45	2 RJ45 and 1 RJ45
Master/slave with Modbus link, Full duplex (RS 232)/Half duplex (RS 485) in Character mode	
0.3...38.4 Kbps	0.3...115.2 Kbps in RS 232 0.3...57.6 Kbps in RS 485
Double shielded twisted pair copper cable	Shielded twisted pair copper cable
32 per segment, 247 max.	2 per drop, 16 per Ethernet remote I/O (R/O) network max.
15 m/49.21 ft (non-isolated), 1000 m/3280.83 ft with insulating case	15 m/49.21 ft with non-isolated RS 232, 1000 m/3280.83 ft with non-isolated RS 485
1	20/36 application-specific channels with BMXP341000/P342●●●● (1 application-specific channel = 1 counter, motion control module or serial link channel)
	36 application specific channels max. per BMXCRA31210 Ethernet drop adaptor: 2 BMXNOM0200 modules
Read/write bits and words, diagnostics in Modbus mode Send and receive character string in Character mode	
–	
–	
–	Standard and Performance (see page 1/8)

BMXP341000/2000	
	BMXNOM0200
BMXP342020	
BMXP3420102/BMXP3420102CL	

2/39
------

For further information, please consult our "Modicon X80 I/O platform" catalog available on our website [www.schneider-electric.com](http://www.schneider-electric.com).

# Modicon M340 automation platform

Communication, integrated ports and modules

**Applications**  
Type of device

**Modbus Plus communication**  
M340 Modbus Plus proxy module (external)



Network protocols	
<b>Structure</b>	Physical interface
	Type of connector
	Access method
	Data rate

Ethernet Modbus/TCP	Modbus Plus
10/100BASE-T	Modbus Plus standard
Two RJ45 connectors	Two 9-way female SUB-D connectors
CSMA-CD	Token ring
10/100 Mbps	1 Mbps

Medium	
<b>Configuration</b>	Maximum number of devices
	Max. length
	Number of links of the same type per station

Double shielded twisted pair copper cable, category CAT 5E (direct or crossover)	Twisted pair copper cable
128	32 per segment 64 for all segments
100 m/328.08 ft	450 m/1476.37 ft per segment 1800 m/5905.49 ft with 3 repeaters
1 max.	

**Standard services**

Modbus/TCP messaging      Modbus Plus messaging

**Conformity class**

–      –

**Embedded Web server service**      Standard service  
Configurable services

Configuration, diagnostics  
–

**Communication services**

Modbus Plus server (scanned by the PLC)	Reading/writing variables
FDR service	Global database
SNMP agent network management service	Peer Cop service

**24 V ~ external power supply**

19.2...31.2 V

**Module types**

**TCSEGDB23F24FA**

**Page**

2/27

**Profibus DP and Profibus PA communication**  
Profibus Remote Master (PRM) module (external)



Ethernet Modbus/TCP	Profibus DP V1 Profibus PA (via gateway)
10BASE-T/100BASE-TX	Isolated RS 485
Two RJ45 connectors (supporting daisy chain topology)	One 9-way female SUB-D connector
CSMA-CD	Master/slave
10/100 Mbps	9.6 Kbps...12 Mbps

Double shielded twisted pair copper cable, category CAT 5E (direct or crossover)	Shielded twisted pair copper cable
Several PRMs can be connected to the Ethernet port on the M340, Premium or Quantum PLC, as long as the I/O scanner capacity is not exceeded	125 slaves
100 m/328.08 ft (copper)	1200/3937 ft (9.6 Kbps), 4800 m/15,747.98 ft with 3 repeaters, 100 m/328.08 ft (12 Mbps), 400 m/1312.33 ft with 3 repeaters
–	

Modbus/TCP messaging	Cyclic and acyclic data exchange with slaves
Transparent Ready Class A20	Class 1 and Class 2
–	
–	

Modbus server (scanned by the PLC)	Master/slave communication
FDR service	Global Control service
SNMP agent network management service	Acyclic communication (read/write) in Class 1 and Class 2 Support for extended diagnostics Auto-scanning service of slaves on the bus

Modbus/TCP messaging      Cyclic and acyclic data exchange with slaves

Transparent Ready Class A20      Class 1 and Class 2

–      –

Modbus server (scanned by the PLC)      Master/slave communication  
FDR service      Global Control service  
SNMP agent network management service      Acyclic communication (read/write) in Class 1 and Class 2  
Support for extended diagnostics  
Auto-scanning service of slaves on the bus

18...30 V

**TCSEGPA23F14F**

2/29

# Modicon M340 automation platform

PlantStruxure Ethernet Architectures  
Logical communication architecture

## Logical communication architecture

Company

Enterprise

Factory

Workshop

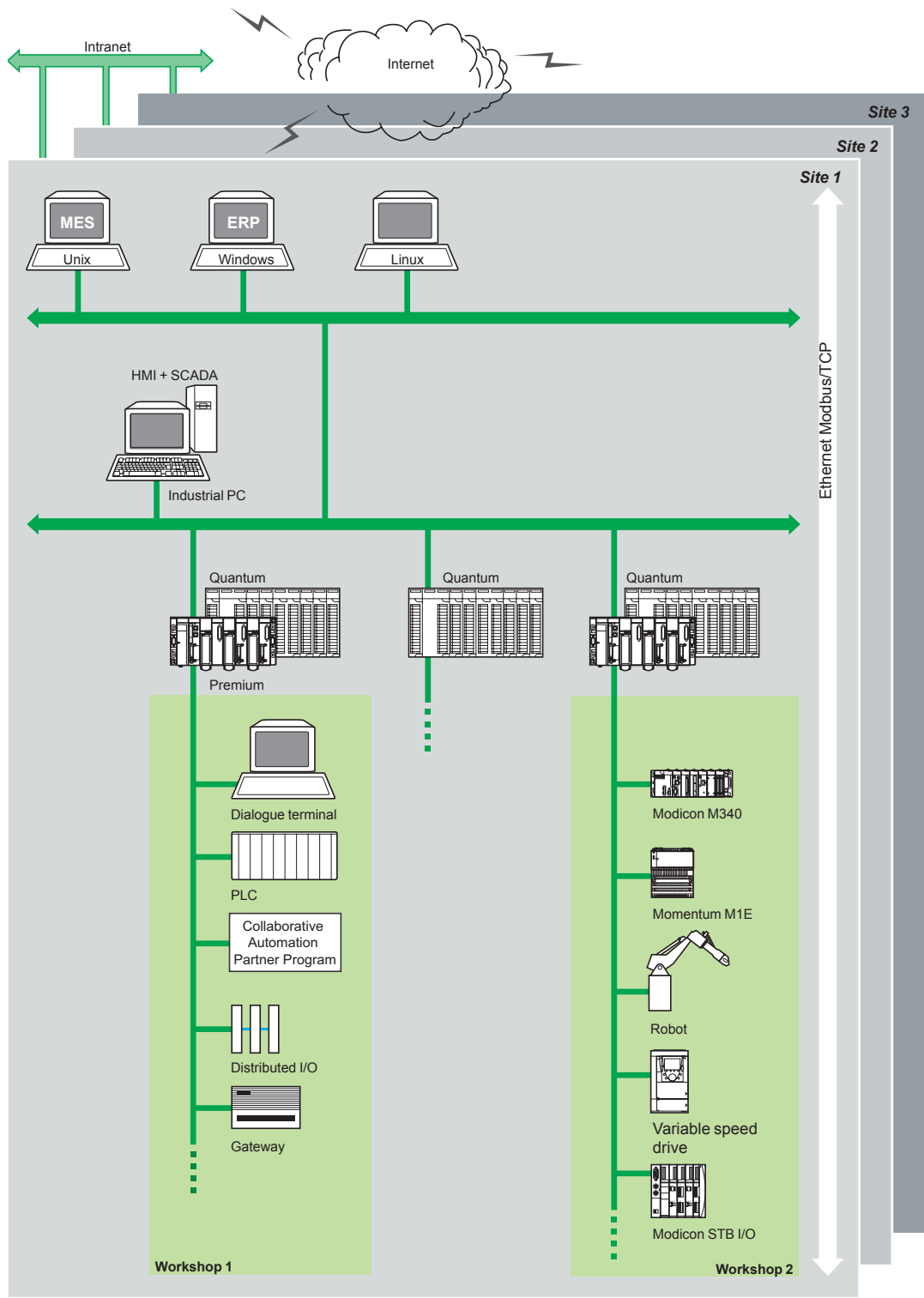

**MES:** Manufacturing Execution System (production management system)  
**ERP:** Enterprise Resource Planning (integrated management software packages)  
**IHM/SCADA:** Human/Machine Interface and Supervision Control And Data Acquisition  
**Gateway:** Gateway to sensor/actuator bus, to installed base network, fieldbus, etc.

Physical communication architecture

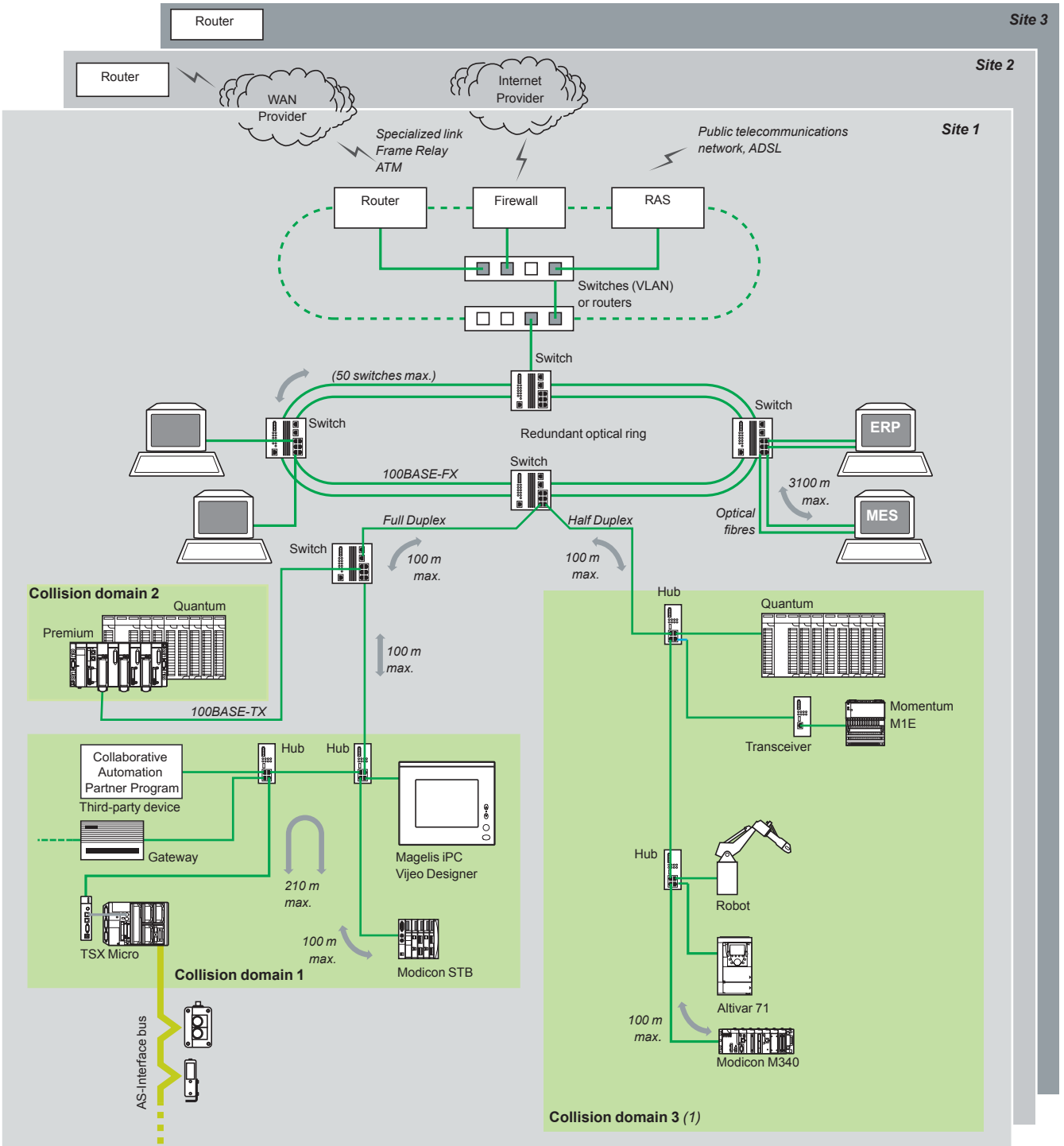

(1) As a general rule, defining several collision domains can increase the size of the architecture and improve performance.

# Modicon M340 automation platform

Ethernet Modbus/TCP network

Ethernet Modbus/TCP communication services

2

## Presentation

**BMXP342020/20302/20302CL** processors via their integrated Ethernet port, **BMXNOE0100/0110** network modules and the **BMXNOR0200H** RTU module provide transparent communication on the Ethernet Modbus/TCP network using Transparent Ready communication services.

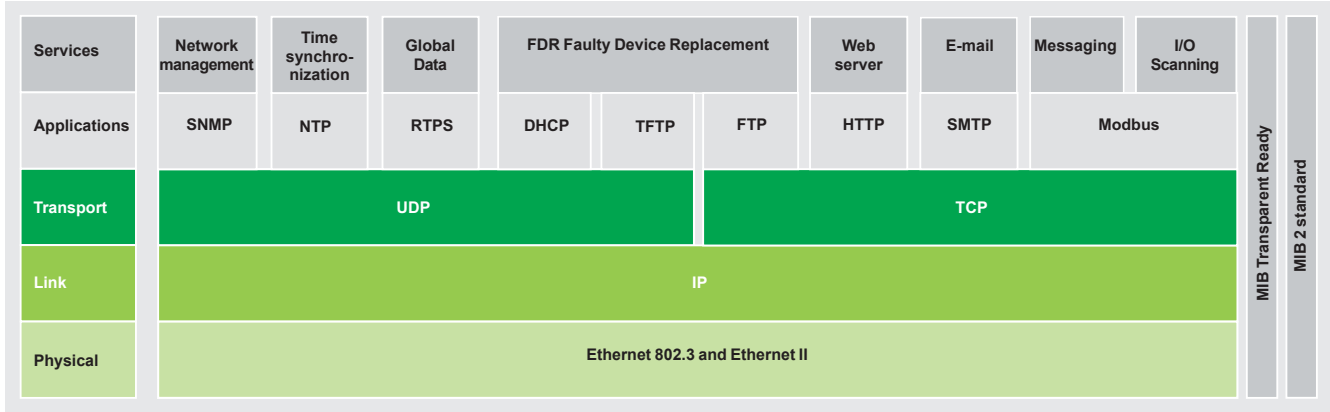

Ethernet communication services for the BMXNOE0100/0110 module

The following Transparent Ready communication services are designed for use in automation applications. They supplement the universal Ethernet services (HTTP, BOOTP/DHCP, FTP, etc):

- Modbus/TCP messaging for class 10 or 30 devices
- I/O Scanning service for class 30 devices
- FDR (Faulty Device Replacement) for class 10 or 30 devices
- SNMP (*Simple Network Management Protocol*) network management for class 10 or 30 devices
- Global Data, for class 30 devices
- Bandwidth management for class 10 or 30 devices
- NTP (*Network Time Protocol*) synchronization for class 30 devices
- E-mail alarm notification via SMTP server, via Unity Pro function block

**Note:** See selection guide on pages 2/2 and 2/3 for the communication services supported by **BMXP342020/20302/20302CL** processors, **BMXNOE0100/0110** network modules and the **BMXNOR0200H** RTU module on the Modicon M340 platform.

The following pages (2/11 to 2/15) present the various options available through all of these services in order to facilitate the optimum choice of solutions when defining a system integrating Transparent Ready devices.

# Modicon M340 automation platform

## Ethernet Modbus/TCP network

### Ethernet Modbus/TCP communication services

#### Functions

##### Ethernet universal services

The universal Ethernet services used are as follows:

■ **HTTP (HyperText Transfer Protocol):**

- This protocol is used for transmitting Web pages between a server and a browser.
- Web servers embedded in Transparent Ready automation products provide easy access to products located anywhere in the world from a standard web browser such as Internet Explorer.

■ **BOOTP/DHCP (RFC1531):**

- These protocols are used to provide devices with IP parameters automatically. This avoids having to manage each device address individually by transferring this management to a dedicated IP address server.
- The DHCP protocol (*Dynamic Host Configuration Protocol*) is used to assign configuration parameters to devices automatically. DHCP is an extension of BOOTP.
- Schneider Electric devices can be "BOOTP clients" (used to retrieve the IP address automatically from a server) or "BOOTP servers" (allowing the device to distribute IP addresses to the network stations).
- Schneider Electric uses standard BOOTP/DHCP protocols for its FDR (*Faulty Device Replacement*) service.

■ **FTP (File Transfer Protocol) (RFCs 959, 2228, and 2640):**

- This protocol provides the basic elements for file sharing. Many systems use it to exchange files between devices.

■ **TFTP (File Transfer Protocol) (RFCs 959, 2228, and 2640):**

- This network transfer protocol can be used to connect to a device and download code to it.
- For example, it can be used to transfer a boot code to a workstation without a disk drive or to connect and download updates of network device firmware.
- Transparent Ready devices implement FTP and TFTP for transferring certain information to or from devices, in particular for downloads of firmware or user-defined Web pages.

■ **SNMP (Simple Network Management Protocol) (RFCs 1155, 1156 and 1157):**

- The SNMP standard manages the various network components via a single system.
- The network management system can exchange data with SNMP agent devices. This function allows the manager to display the status of the network and devices, modify their configuration and feed back alarms in the event of a fault.
- Transparent Ready devices are SNMP-compatible and can be integrated naturally in a network managed via SNMP.

■ **COM/DCOM (Distributed Component Object Model) (RFCs 1155, 1156 and 1157):**

- COM/DCOM or OLE (*Object Linking and Embedding*) protocol is the name of the technology consisting of Windows objects which enables transparent communication between Windows applications.
- These technologies are used in the OFS (*OLE for Process Control Factory Server*) data server software.

##### Modbus standard communication protocol

Modbus protocol, the industry communication standard since 1979, has been combined with Ethernet Modbus/TCP, the medium for the Internet revolution, to form Modbus/TCP, a completely open Ethernet protocol.

The development of a connection to Modbus/TCP does not require any proprietary component, nor purchase of a license.

This protocol can easily be combined with any product supporting a standard TCP communication stack. The specifications can be obtained free of charge from the following website: [www.modbus-ida.org](http://www.modbus-ida.org).

# Modicon M340 automation platform

Ethernet Modbus/TCP network

Ethernet Modbus/TCP communication services

2

1 Modicon M340 device with I/O Scanning service

2 Device with Modbus TCP messaging in server mode

## Functions (continued) I/O Scanning service

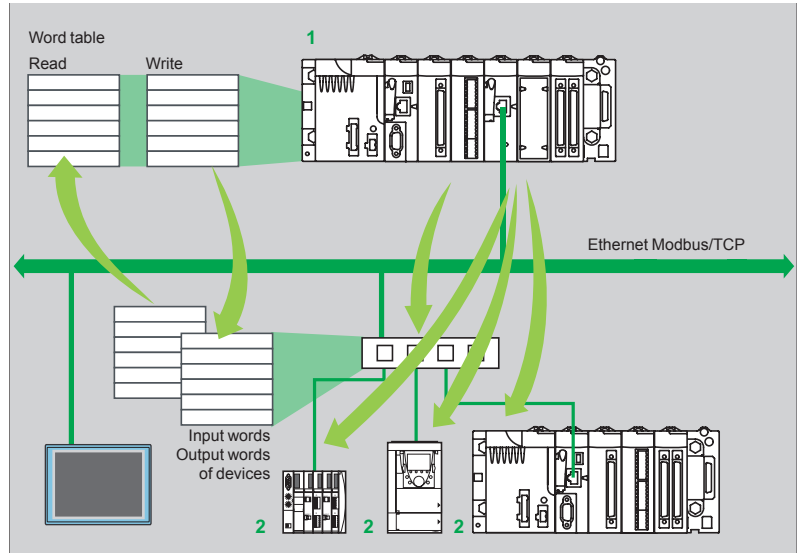

The I/O Scanning Service is used to manage the exchange of remote I/O states on the Ethernet network after a simple configuration operation, with no need for special programming.

I/O scanning is performed transparently by means of read/write requests according to the Modbus client/server protocol on the TCP profile.

This principle of scanning via a standard protocol enables a device with the I/O Scanning service to communicate with any device supporting Modbus TCP messaging in server mode.

This service can be used to define:

- A word zone reserved for reading inputs
- A word zone reserved for writing outputs
- Refresh periods independent of the PLC scan

During operation, the module:

- Manages TCP connections with each remote device
- Scans devices and copies the I/O to the configured word zone
- Feeds back status words used to check that the service is working correctly from the PLC application
- Applies pre-configured fallback values if a communication problem occurs

A range of hardware and software products is available enabling the I/O Scanning protocol to be implemented on any type of device that can be connected to the Ethernet network (please consult the Modbus-IDA website: [www.modbus-ida.org](http://www.modbus-ida.org)).

## Characteristics

- Each Modicon M340 station can exchange a maximum of 100 words for writing and 125 words for reading.
- Maximum size in the Modicon M340 PLC that manages the service (64 stations max.) with **BMXNOE0100/0110** and **BMXNOC0401** network modules: 2 Kwords (input) and 2 Kwords (output).

## I/O Scanning service diagnostics

I/O Scanning service diagnostics can be performed in one of five ways:

- Via the application program from a specific PLC data zone
- From the setup software debug screen
- From the PLC system diagnostic function displayed by means of an internet browser on a PC station
- Using standard SNMP manager software

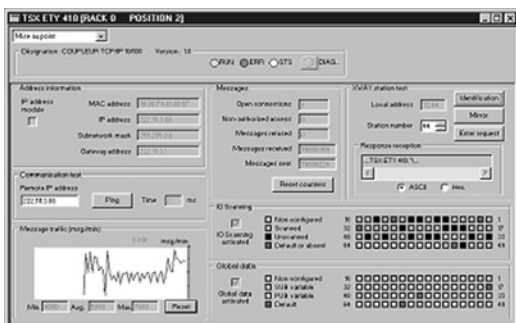



# Modicon M340 automation platform

Ethernet Modbus/TCP network

Ethernet Modbus/TCP communication services

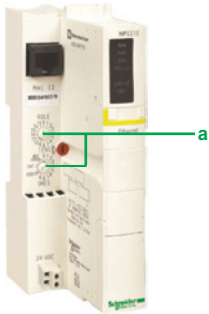

NIM network module for Modicon STB I/O

## Functions (continued)

### FDR (Faulty Device Replacement) service

The Faulty Device Replacement service uses standard address management technologies (BOOTP, DHCP) and the TFTP (*Trivial File Transfer Protocol*) file management service, with the aim of simplifying maintenance of Ethernet devices. The FDR service is used to replace a faulty device with a new device with the guarantee that it will be detected, reconfigured and automatically rebooted by the system.

The main steps in replacement are:

- 1 A device using the FDR service malfunctions.
- 2 Another similar device is taken from the maintenance store, preconfigured with the Device name for the faulty device, then reinstalled on the network. Depending on the device, addressing can be performed using rotary selector switches (as for Modicon STB distributed I/O **a**, or Modicon OTB for example) or can be given using the keypad integrated in the device (as for Altivar variable speed drives for example).
- 3 The FDR server detects the new device, allocates it an IP address and transfers the configuration parameters to it.
- 4 The substituted device checks that all these parameters are indeed compatible with its own characteristics and switches to operational mode.

The FDR server can be the **BMXNOE0100/0110** Ethernet module or the **BMXNOC0401** module.



**NTP Configuration**

---

**NTP Server Configuration**

IP Address of Primary NTP Server:

IP Address of Secondary NTP Server:

Polling Period:  sec

**Time Zone**

(GMT-05:00)Eastern Standard Time@New York

Automatically adjust clock for daylight saving change

## NTP time synchronization service

### Presentation

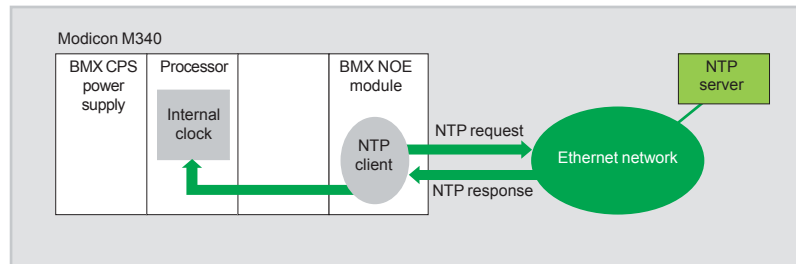

The time synchronization service is based on NTP (*Network Time Protocol*) which is used to synchronize the time of a client or a server on Ethernet from a server or another reference time source (radio, satellite, etc).

### Operation

**BMXNOE0100/0110**, **BMXNOC0401** and **BMXNOR0200H** Ethernet Modbus/TCP modules have an NTP client component.

These modules connect to an NTP server using a client request (*Unicast*) in order to update their local time. The module clock is updated periodically (1 to 120 s) with typical precision of 5 ms. If the NTP server cannot be reached, the Ethernet TCP/IP module switches to a standby NTP server.

The PLC processor clock is therefore itself updated with a precision of 5 ms. A function block is used to read this clock, thus enabling Unity Pro application events or variables to be time and date stamped.

The Ethernet module is configured by means of a Web page. The time zone can be configured. A time synchronization service (NTP) diagnostic Web page is also available.

Information on the time synchronization service (NTP) is also available in the Transparent Ready private MIB, which can be accessed via the SNMP network management service.

**NTP Diagnostics**

---

NTP Status: NOT OK

**NTP Server Status**

Link to the NTP Server:  Sense Time Quality within  microseconds

Server: Primary

**NTP Request Statistic**

Number of Requests:     Number of Errors:

Number of Responses:     Last Error:

**NTP Date and Time**

Date:     Time:     DST Status:

Time Zone: (GMT-05:00)Eastern Standard Time@New York

# Modicon M340 automation platform

Ethernet Modbus/TCP network

Ethernet Modbus/TCP communication services

2

## Functions (continued)

### Global Data service

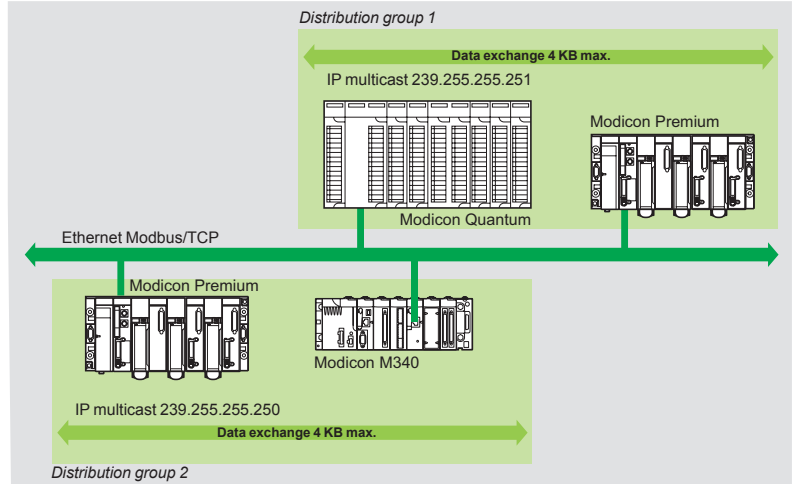

The Global Data service performs data exchanges in real time between stations belonging to the same distribution group. It is used to synchronize remote applications, or to share a common database between a number of distributed applications. Exchanges are based on a standard producer/consumer protocol, guaranteeing optimum performance with a minimum load on the network. This RTPS (*Real Time Publisher Subscriber*) protocol is promoted by Modbus-IDA (*Interface for Distributed Automation*), and is already a standard adopted by several manufacturers.

### Characteristics

A maximum of 64 stations can participate in Global Data within a single distribution group. Each station can:

- Publish one 1024-byte variable. The publication period can be configured from 1 to n processor master task (*Mast*) periods.
- Subscribe to between 1 and 64 variables. The validity of each variable is controlled by status bits (*Health Status bits*) linked to a refresh timeout configurable between 50 ms and 1s. Access to an element of the variable is not possible. The total size of subscribed variables amounts to 4 K contiguous bytes.

To further optimize the performance of the Ethernet network, Global Data can be configured with the "multicast filtering" option which, together with switches in the ConneXium range, broadcasts data only to Ethernet ports where there is a Global Data service subscriber station. If these switches are not used, Global Data is sent in "multicast" mode to all switch ports.

### Global Data service diagnostics

The diagnostic screens use a colour code to show the Global Data status:

- Configured/not configured/faulty.
- Published/subscribed.

Global Data service diagnostics can be performed in one of five ways:

- Via the application program from a specific PLC data zone.
- From the setup software debug screen.
- From the PLC system diagnostic function displayed by means of an internet browser on a PC screen.
- Using standard SNMP manager software.

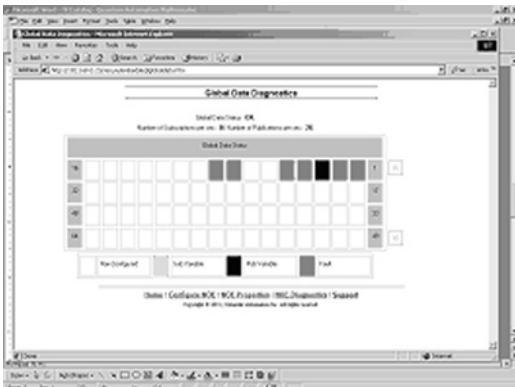

# Modicon M340 automation platform

Ethernet Modbus/TCP network

Ethernet Modbus/TCP communication services

## Functions (continued)

### SNMP network management service

From a network management station, SNMP (*Simple Network Management Protocol*) monitors and checks all components of the Ethernet architecture and thus ensures quick diagnostics in the event of a problem.

It is used to:

- Interrogate network components such as computer stations, routers, switches, bridges or terminal devices in order to view their status.
- Obtain statistics about the network to which the devices are connected.

This network management software complies with the conventional client/server model. However, to avoid confusion with other communication protocols that use this terminology, we talk instead about:

- Network manager for the client application that operates on the computer station.
- SNMP agent for the network device server application.

Transparent Ready devices can be managed by any SNMP network manager, including HP Openview and IBM Netview.

Standard SNMP (*Simple Network Management Protocol*) is used to access configuration and management objects contained in the device MIBs (Management Information Bases). These MIBs must comply with certain standards to be accessed by any commercially-available manager, but depending on the complexity of products, manufacturers can add certain objects to private databases.

The Transparent Ready private MIB presents management objects specific to the Schneider Electric offer. These objects simplify the installation, setup and maintenance of Transparent Ready devices in an open environment using standard network management tools.

Transparent Ready devices support 2 levels of SNMP network management:

- The Standard MIB II interface: This interface accesses a first level of network management. It enables the manager to identify the devices making up the architecture and retrieve general information about the configuration and operation of Ethernet Modbus/TCP interfaces.
- The Transparent Ready MIB interface: This interface improves the management of Transparent Ready devices. This MIB has a set of data enabling the network management system to supervise all the Transparent Ready services. The Transparent Ready MIB can be downloaded from the FTP server of any Transparent Ready Ethernet module in a PLC.

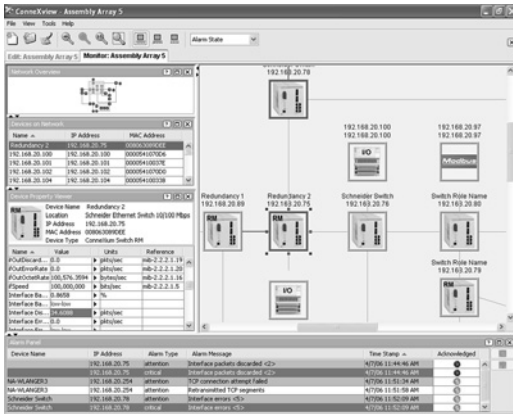

Automatic recognition of IP devices via the ConneXview diagnostic software for Ethernet industrial networks



## Presentation of Web services

The standard Web server functions are integrated in a wide variety of Schneider Electric Ethernet products: Modicon automation platform processors and Ethernet modules, distributed I/O modules, variable speed drives and gateways. These functions are mainly integrated in **BMXP342020/20302/20302CL** processors, in **BMXNOE0100/0110** and **BMXNOC0401** Ethernet network modules, in the **BMXNOR0200H** RTU module, and the **TCSEGDB23F24FA** Modbus Plus proxy module on the Modicon M340 platform.

From a simple Internet browser, the standard Web server authorizes the following “ready-to-use” functions:

- Remote diagnostics and maintenance of products
- Display and adjustment of products (read/write variables, status)

With the **BMXNOE0110** FactoryCast module equipped as standard with the **BMXRWSFC032M** card, the Web server also offers the following functions:

- Management of PLC system and application alarms with partial or total acknowledgement (ready-to-use Alarm Viewer function pages)
- Hosting and display of Web pages created by the user

The embedded Web server is a real-time data server. All the data can be presented in the form of standard Web pages in HTML format and can therefore be accessed using any Web browser that supports the embedded Java code. The standard functions provided by the Web server are supplied “ready-to-use” and thus do not require any programming of either the PLC or the client PC device supporting a Web browser.

## Standard Web server on the Modicon M340 platform

### Rack Viewer PLC diagnostics function

The Rack Viewer function can be used for PLC system and I/O diagnostics. It displays the following in real time:

- Status of LEDs on the PLC front panel
- The PLC type and version
- Hardware configuration of the PLC including status of the system bits and words
- Detailed diagnostics of:
  - Each of the I/O module channels or application-specific channels in the configuration
  - Devices connected to the CANopen bus

### Data Editor read/write function for PLC data and variables

The Data Editor function can be used to create tables of animated variables for real-time read/write access to PLC data in the form of lists.

Various animation tables containing specific application variables to be monitored or modified can be created by the user and saved in the standard Web server module.

In addition to the functions provided by the standard Web server, the **BMXNOE0110** Ethernet module's FactoryCast Web server offers the following:

- Display of variables: Variables can be entered and displayed either in their symbolic form (S\_Pump 234) or as their address (%MW99).
- Write access to variables: This can be enabled or disabled for each of the variables using the FactoryCast module configuration software.
- Read/write function: This can be used on tools such as a pocket PC or PDA terminal.



Modicon M340 hardware configuration



Data Editor variables table

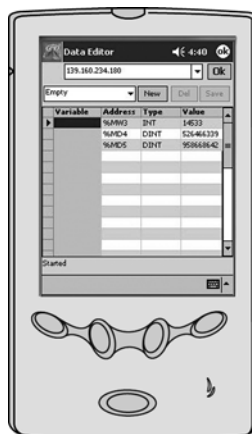

# Modicon M340 automation platform

Ethernet Modbus/TCP network  
FactoryCast Web services

## BMXNOE0100 module FactoryCast Web server

In addition to the standard services, the embedded Web server in the **BMXNOE0110** FactoryCast module offers the functions described below.

### Alarm Viewer function

The alarm viewer is a ready to use, password-protected function. It is used to process alarms (display, acknowledgement and deletion) managed at PLC level by the system or using diagnostic function blocks known as DFBs (system-specific diagnostic function blocks and application-specific diagnostic function blocks created by the user).

These alarms are stored in the diagnostic buffer managed by the Modicon M340 platform (dedicated memory space for storing all the diagnostic events).

The diagnostic viewer is a Web page comprising a list of messages, which displays the following information for each alarm:

- Dates and times of the occurrence/removal of a fault
- Alarm message
- Alarm status
- Type of associated diagnostic function block (DFB)

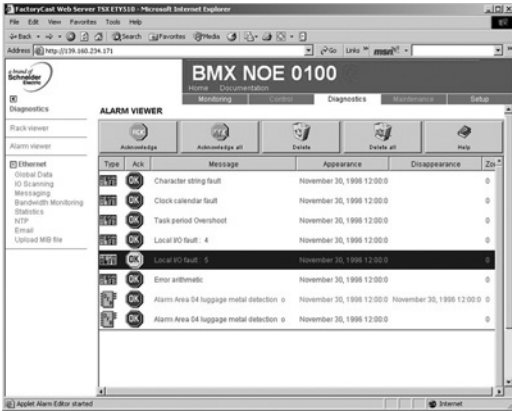

Alarm display from the diagnostic buffer

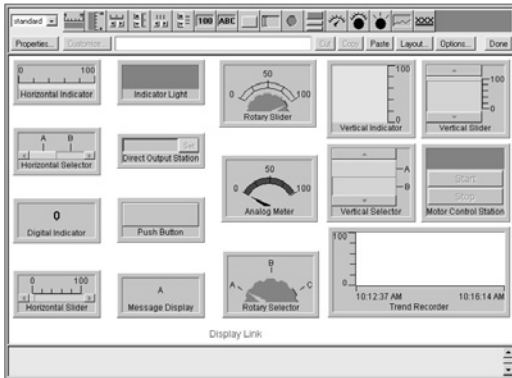

Library of predefined graphic objects

### Graphic Data Editor function

This function is used to create the graphic views animated by the PLC variables that can be accessed via their address or via their symbol (access to located data). The ready-to-use graphic editor is available in online mode when connected to the **BMXNOE0110** module.

These views are created from a library of predefined graphic objects by simple copy/paste operations. The objects are configured to suit the user's requirements (colour, PLC variables, name, etc).

List of graphic objects available:

- Analog and digital indicators
- Horizontal and vertical bar charts
- Boxes for displaying messages and entering values
- Pushbutton boxes
- Trend recorders
- Vats, valves, motors, etc

Customized graphic objects can be added to this list and can be reused in user Web pages that have been created using standard software for editing HTML pages. The views thus created are saved in the **BMXNOE0110** module and can be displayed using any Web browser.

### User Web page hosting and display function

The **BMXNOE0110** FactoryCast module has a 16 Mbyte non-volatile memory which is accessed in the same way as a hard drive. This allows hosting of Web pages and any user-defined Word or Acrobat Reader document (for example, maintenance manuals, wiring diagrams, etc).

Web pages can be created using any standard tool for creation and editing in HTML format. They can be enhanced by inserting animated graphic objects linked to PLC variables. These animated objects are created using the Graphic Data Editor. They are then downloaded to the **BMXNOE0110** module via the FactoryCast Web server configuration software.

These user Web pages can be used, for example, to:

- Display and modify all PLC variables in real time
- Create hyperlinks to other external Web servers (documentation, suppliers, etc)

This function is particularly suitable for creating graphic interfaces used for the following purposes:

- Real-time display and supervision
- Production monitoring
- Diagnostics and help with maintenance
- Operator guides

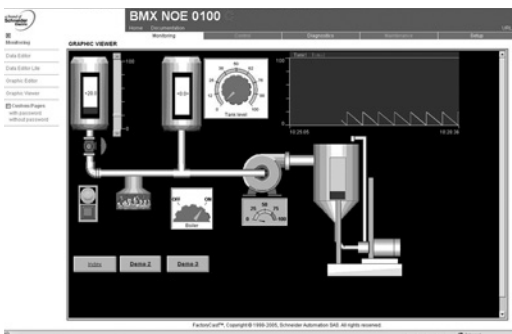

Real-time supervision graphic interface

# Modicon M340 automation platform

Ethernet Modbus/TCP network  
Web Designer configuration software



Web Designer

2

## Web Designer configuration software

The Web Designer software is supplied on CD-ROM with the **BMXNOE0110** Ethernet network module and the **BMXNOR0200H** RTU module.

The software is used for the configuration and administration of the Web server embedded in the modules. It makes it easier to create customized Web human/machine interfaces (HMIs). It is also used for easy configuration of embedded advanced processing functions for numerous Web server modules and RTU modules:

- FactoryCast Web server modules for Modicon M340, Quantum and Premium PLCs
- FactoryCast HMI Web server modules for Modicon Premium and Quantum PLCs
- ETG 1000/3000 FactoryCast Gateways for remote access
- RTU module for Modicon M340

Web Designer software is compatible with the Windows 2000 SP2, Windows XP Professional and Windows Vista Professional 32-bit operating systems. For optimum use, it requires Java Virtual Machine 1.4.2 minimum.

Web Designer software offers the following functions:

■ **Setting the Web Designer function parameters:**

- Definition of access security, passwords
- Importing of PLC symbol databases
- Definition of access to write-enabled variables

■ **Management of the Web site:**

- Management of default site Web pages
- Management of user site Web pages
- Graphic Data Editor for animating Web pages (*BMXNOE0110 module only*). This integrated editor can be used for easy customization of graphic objects: bar charts, gauges, LEDs, curves, cursors, operator input fields, alphanumeric display fields, buttons, etc.

- Downloading of Web pages between the PC and the module
- Debugging of Web pages in online mode or in simulation mode (including animations and Java beans)

■ **Simulation mode:**

- The application and the Web site (including the Java animations) can be set up in online mode or in simulation mode.
- Simulation mode is used to test the operation of the Web application without a module (with no physical connection to a PLC) thereby simplifying debugging.

■ **Creation of user Web pages:**

- User Web pages are created graphically using an external HTML editor (FrontPage or similar, not supplied).
- User Web pages created with the graphic editor are actual animated supervisory control screens and can be used to monitor the process. Based on Web technologies (HTML and Java), they provide real-time access to PLC variables using the FactoryCast library of graphic objects (Java beans) (*BMXNOC0401 module only*) (1).

■ **Data Logging (for BMXNOR0200H module only):**

- This service is used to archive the application data: events, alarms, process data, device states, process values, etc.
- The data are logged in CSV files in ASCII format, which are stored locally on the SD memory card in the BMXNOR0200H module.

■ **Sending alarm notifications or reports via Email or SMS (BMXNOR0200H module only):**

- The BMXNOR0200H module can send e-mails or SMS messages automatically in real time in order to send alarm notifications, maintenance calls, production reports or factory status updates, etc to specified users.
- E-mails or SMS messages are sent when a predefined application or process is triggered.

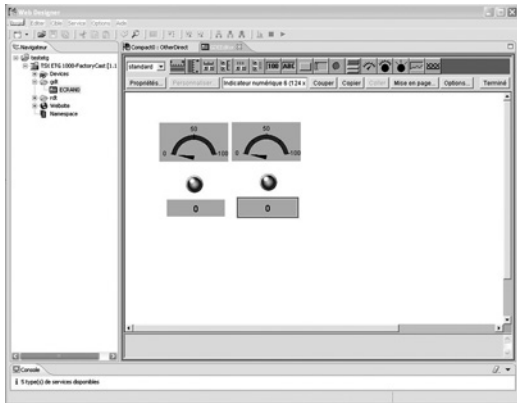

Graphic Data Editor

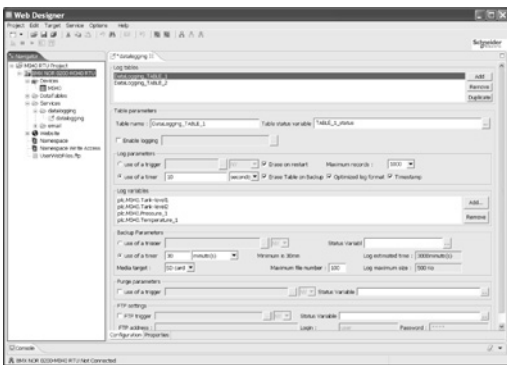

Configuring the Data Logging function for BMXNOR0200H module

(1) Web Designer includes a plug-in for FrontPage 2000. This plug-in makes it easier to set up animations for real-time access to the PLC variables in HTML pages created by the user. They are created in the HTML editor by simply inserting customized graphic objects.

# Modicon M340 automation platform

Ethernet Modbus/TCP network  
SOAP/XML Web services



## SOAP/XML Web services

**BMXNOE0110**, **BMXNOC0401** Ethernet network modules and **BMXNOR0200H** RTU modules incorporate a standard SOAP/XML data server that provides direct interoperability between control system devices and computer management applications (MES, ERP, SAP, .Net application, etc).

## SOAP/XML Web services embedded in the PLC

These Web services conform to the **W3C** (*World Wide Web Consortium*) Web service standards. They offer standard open communication resources thanks to which the control peripherals can interact directly with computer management applications using a non-proprietary SOAP protocol.

SOAP/XML Web services are based on the following standards:

- **SOAP** (*Simple Object Access Protocol*), the exchange protocol executed via the HTTP (*HyperText Transfer Protocol*) channel
- **WSDL** (*Web Services Description Language*), in XML format
- **XML** (*eXtensible Markup Language*), the universal standard for data exchange

## ModbusXMLDa Web services: SOAP server interface

The implementation of **ModbusXMLDa** (*Modbus XML Data access*) services in control system device Web servers means IT engineers can easily create their own application to access the desired information directly in the PLC, in real time.

Applications such as Microsoft.NET, SQL Server, Microsoft Office (Excel), IBM (WebSphere), SUN (Java, Eclipse), Lotus, Oracle, SAP, MES, ERP, etc can interact directly with the PLC module Web server.

Exchanges are initiated by the SOAP client application (the server responds to these requests). Data exchanges are made in XML standard format in response to a request using the SOAP protocol.

### ■ Step 1: Creation of the client application with learning of the Web services.

The development environment (for example, Visual Studio .NET) looks in the FactoryCast server for the list of available services and their WSDL standard interfaces provided by the module.

■ **Step 2: Development of the client application.** The developer integrates the Web service functions using the code retrieved at step 1 of the learning process.

■ **Step 3: Execution of the client application.** The client application communicates in real time with the FactoryCast Web server module using the SOAP protocol.

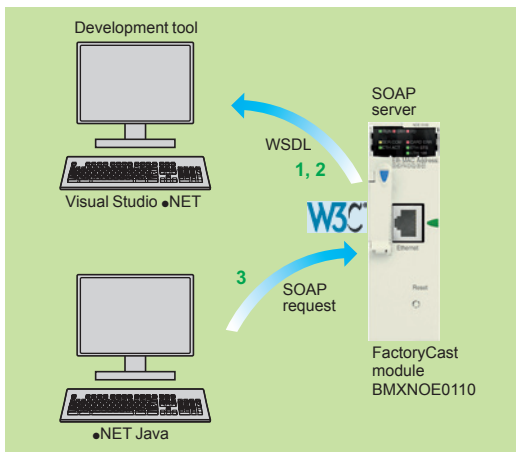

# Modicon M340 automation platform

Processors with integrated Ethernet Modbus/TCP port

2

## Presentation

**BMXP342020**, **BMXP3420302** and **BMXP3420302CL** standard format Modicon M340 processors with integrated Ethernet port occupy a single slot marked "00" in the rack on the Modicon M340 platform.

## Description

The front panel of **BMXP342020/20302/20302CL** Modicon M340 processors features:

- 1 A safety screw for locking the module in a slot in the rack.
- 2 A display block with 8 LEDs, including 3 relating to the Ethernet port:
  - ETHACT LED (green): Activity on the Ethernet network
  - ETH STS LED (green): Ethernet network status
- Depending on processor version:
  - Version 1: ETH 100 LED (green): data rate on the Ethernet network (10 or 100 Mbps)
  - Version 2 and later: ETH LNK LED (green): Ethernet link status
- 3 A mini B USB connector for a programming terminal (or Magelis XBTGT/GK/GTW HMI terminal).
- 4 A slot equipped with its Flash memory card for saving the application and activating the standard Web server (Transparent Ready class B10) (1).
- 5 An RJ45 connector for the connection to the Ethernet network.

Depending on model:

- 6 **BMXP342020** processor: An RJ45 connector for the Modbus serial link or Character mode link (RS 232C/RS 485, 2-wire, non-isolated)
- 7 **BMXP3420302/20302CL** processor: A 9-way SUB-D connector for the master CANopen machine and installation bus.

**On the rear panel:** 2 rotary switches for selecting the IP address using one of 3 assignment methods:

- Address set by the position of the two switches
- Address set by the application parameters
- Address set by the Ethernet network BOOTP server

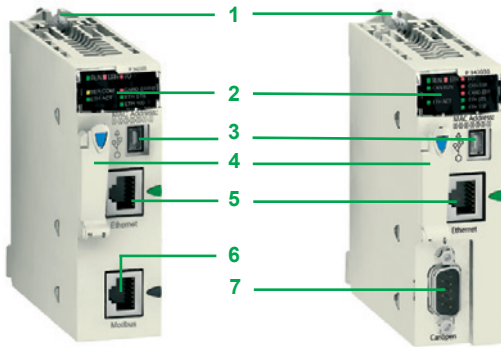

BMXP342020



BMXP3420302  
BMXP3420302CL

## References

Description	I/O capacity Memory capacity	Other integrated communication ports	Reference	Weight kg/ lb
<b>Processors with integrated Ethernet Modbus/TCP link</b> Transparent Ready class B10	1024 discrete I/O 256 analog I/O 36 app-specific channels 4096 KB integrated	Modbus serial link or Character mode	<b>BMXP342020</b>	0.205/ 0.452
		CANopen bus	<b>BMXP3420302</b>	0.215/ 0.474
<b>Processors with integrated Ethernet Modbus/TCP link without memory card</b> Transparent Ready class B10	1024 discrete I/O 256 analog I/O 36 app-specific channels 4096 KB integrated	CANopen bus	<b>BMXP3420302CL</b> (1)	0.215/ 0.474

(1) Memory card must be ordered separately for the BMXP3420302CL processor (see page 1/13).



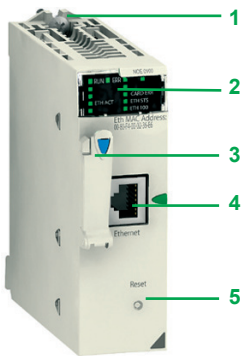

### Presentation

**BMXNOE0100** and **BMXNOE0110** standard format modules occupy a single slot in the rack on the Modicon M340 platform equipped with a Standard or Performance processor.

### Description

The front panel of **BMXNOE0100** and **BMXNOE0110** modules features:

- 1 A safety screw for locking the module in a slot in the rack.
  - 2 A display block with 6 LEDs, including 3 relating to the Ethernet port:
    - ETH ACT LED (green): Activity on the Ethernet network
    - ETH STS LED (green): Ethernet network status
- Depending on processor version:
- Version 1: ETH 100 LED (green): data rate on the Ethernet network (10 or 100 Mbps)
  - Version 2 and later: ETH LNK LED (green): Ethernet link status
- 3 A slot equipped with its Flash memory card for saving the application and activating the Web server (Transparent Ready class B30 or C30 depending on the model).
  - 4 An RJ45 connector for connection to the Ethernet network.
  - 5 A pencil-point RESET pushbutton for a cold restart of the module.

**On the rear panel:** 2 rotary switches for assigning the IP address in one of three ways:

- Address set by the position of the two switches
- Address set by the application parameters
- Address set by the Ethernet network BOOTP server



BMXNOE0100/0110

### References

Description	Data rate	Transparent Ready Class	Reference	Weight kg/lb
Ethernet Modbus/TCP network modules	10/100 Mbps	B30	<b>BMXNOE0100</b>	0.200/ 0.441
		C30	<b>BMXNOE0110 (1)</b>	0.200/ 0.441

### Spare parts

Description	Size	Supplied as standard with	Reference	Weight kg/lb
Flash memory cards	8 MB	<b>BMXNOE0100</b>	<b>BMXRWSB000M</b>	0.002/ 0.004
	32 MB	<b>BMXNOE0110</b>	<b>BMXRWSFC032M</b>	0.002/ 0.004

(1) The Web Designer software is supplied on CD-ROM with the **BMXNOE0110** module. This software is used for the configuration and administration of the Web server embedded in the module, see page 2/18.

### Presentation

The **BMXNOC0401** network module acts as an interface between the M340 PLC and other Ethernet network devices via the Modbus/TCP and EtherNet/IP communication protocols.

The standard format **BMXNOC0401** network module occupies a single slot in the rack of the Modicon M340 platform.

This must be equipped with a Standard **BMXP341000** or Performance **BMXP342000** processor.

### Functions

The **BMXNOC0401** module offers the following functions:

- Modbus/TCP and EtherNet/IP protocols operating simultaneously.
- Ring topologies on 2 Ethernet ports using RSTP (*Rapid Spanning Tree Protocol*).
- Priority of Ethernet packets using QoS (*Quality of Service*) service.
- Automatic module configuration recovery using FDR (*Faulty Device Replacement*) service.
- Support for SCADA functions via the OPC *protocol*.
- Embedded Web server for application monitoring and module diagnostics.
- Sharing data between PLCs.
- Network management using SNMP (*Simple Network Management Protocol*).

### Description

The front panel of the **BMXNOC0401** module features:

- 1 A safety screw for locking the module in a slot in the rack.
- 2 A display block with 5 LEDs:
  - RUN LED (green): Operating status
  - ERR LED (red): Error detected
  - MS LED (green/red): Module status
  - NS LED (green/red): Network connection status
  - ETH STS LED (amber): Ethernet link status
- 3 Four RJ45 connectors for connection to the Ethernet network. The two bottom connectors **3b** support ring topologies (RSTP protocol).

Each RJ45 connector has two associated LEDs:

- LNK LED (yellow): Ethernet link established
- ACT LED (green): Transmission/reception activity

**On the rear panel**, 2 rotary switches for selecting the IP address module using one of 4 assignment methods:

- IP address defined by the Ethernet network BootP server
- IP address configured by the application parameters
- Default IP address
- IP address defined by the position of the 2 rotary switches

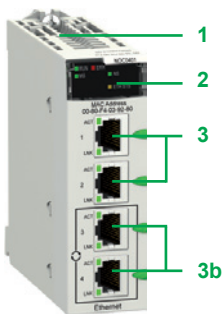

# Modicon M340 automation platform

Modbus/TCP and EtherNet/IP network module



BMXNOC0401

## References

Description	Data rate	Transparent Ready Class	Reference	Weight kg/lb
EtherNet/IP, Modbus/TCP network module	10/100 Mbps	B30	<b>BMXNOC0401 (1)</b>	0.345/ 0.761

(1) The "Unity Pro configuration tool" software is supplied on CD-ROM with the module. This software is used to update the Unity Pro hardware catalogue (addition of the new module DTMs).



# Modicon M340 automation platform

## Web servers and gateways

**Applications** Standalone Web Gateway/Server module for remote access

**Type** FactoryCast Gateway ETG10●0



**Target products** Type Any device supporting Modbus Any device supporting Uni-Telway

<b>Network/Remote access services</b>	Remote access	Intranet or via external modem and integrated RAS function	Intranet or modem, external modem and integrated RAS function
	Gateway function	Remote programming, downloading via FTP, access to Web server via web browser	
	Serial protocols	Ethernet to Modbus serial Modem to Modbus serial and Ethernet	Ethernet to Uni-Telway serial Modem to Uni-Telway and Ethernet
	Ethernet protocols	Modbus master	Uni-Telway slave
	TCP/IP protocols	Modbus/TCP	Modbus/TCP Uni-TE (Premium, Micro)
	Security	BootP/DHCP, DNS, SNMP agent, SMTP client, NTP client (1), FTP	BootP/DHCP, DNS, SNMP agent, SMTP client, NTP client (1), FTP
		Protection by IP address filtering and passwords	

<b>Web server</b>	Characteristics	HTTP and FTP server, 8 MB memory available for user, hosting of user Web pages and documents (doc, pdf, Excel)	
-------------------	-----------------	--	--

<b>Predefined services</b>	Configuration	Via Web Designer software or predefined Web pages	
	Diagnostics	Serial device diagnostics via predefined Web pages	
	Monitoring	Monitoring via animation tables Display of PLC Unity program in a Web page	Monitoring of devices and application via animation tables (read/write variables) Display of PLC Unity program in a Web page
	Alarm management	-	

<b>Customizable services</b>	Graphic views	Graphic monitoring via animated views (integrated graphic editor)	
	Unity Pro operator screen	-	
	User Web pages	Graphic monitoring via animated Web pages created by the user	

<b>Advanced and HMI services</b>	Calculation scripts	-	
	E-mail service	Alarm notification by e-mail	
	Data logging	-	
	Database connection	-	
	Report service	-	
	Recipe service	-	

<b>Application development software</b>	Web Designer (supplied with each module)		
---	--	--	--



Web Designer

<b>References</b>	TSXETG1000	TSXETG1010
	www.schneider-electric.com	

**Catalog or website** www.schneider-electric.com

(1) Except with TSXP57103M/153M Modicon Premium processors, which do not have the NTP service.

**Applications** Standalone Web Gateway/Server modules for remote access

**Type** FactoryCast HMI Gateway ETG30●●



**Target products** Any Modicon PLC or third-party device supporting Modbus

<b>Network/Remote access services</b>	Intranet or modem, external modem and integrated RAS function	Intranet or modem RTC modem and integrated RAS function	Intranet or modem GSM modem and integrated RAS function
	Remote programming, downloading via FTP, access to Web server via web browser		
	Ethernet to Uni-Telway serial, modem to Modbus serial and Ethernet		
	Modbus master		
	Modbus/TCP		
	DHCP, DNS, SNMP agent, SMTP client, NTP client (1), FTP		
Protection by IP address filtering and passwords			

<b>Web server</b>	Characteristics	HTTP and FTP server, 32 MB memory available for user Web pages, memory expansion using Compact Flash cards 1 GB max., hosting of user Web pages and documents (doc, pdf, Excel)	
-------------------	-----------------	---	--

<b>Predefined services</b>	Configuration	Via Web Designer software or predefined Web pages	
	Diagnostics	Network diagnostics, serial and Ethernet device diagnostics via predefined Web pages	
	Monitoring	Monitoring of devices and application via animation tables (read/write variables) Display of PLC Unity program in a Web page	
	Alarm management	-	

<b>Customizable services</b>	Graphic views	Graphic monitoring via animated views (integrated graphic editor)	
	Unity Pro operator screen	-	
	User Web pages	Graphic monitoring via animated Web pages created by the user	

<b>Advanced and HMI services</b>	Arithmetic and logical scripts	-	
	Alarm notification by e-mail/SMS	Alarm notification by e-mail/SMS	
	Data logging	Data recorded in the module with date and time stamping (CSV files)	
	Database connection	Direct recording in an SQL, Oracle, or MySQL server	
	Report service	Dynamic HTML report management	
	Recipe service	Management of "Recipe" data (storage and review locally or in remote database)	

<b>Application development software</b>	Web Designer (supplied with each module)		
---	--	--	--



Web Designer

<b>References</b>	TSXETG3000	TSXETG3010 (PSTN modem)	TSXETG3021 (GSM900/1800 MHz band) TSXETG3022 function (GSM850/1900 MHz band)
	www.schneider-electric.com		

**Catalog or website** www.schneider-electric.com

(1) Except with TSXP57103M/153M Modicon Premium processors, which do not have the NTP service.

# Modicon M340 automation platform

## Modbus Plus Proxy module

2

### Presentation

The **TCSEGDB23F24FA** Modbus Plus Proxy module is a network gateway that allows Modicon M340 and M580 PLCs to communicate with existing Modbus Plus devices.

It is not necessary to modify the applications for these devices to communicate with the Modicon M340 and M580 PLCs, since the module automatically addresses the platforms and the various communication functions between the M340/M580 and other PLC platforms (especially 984LL).

The Modbus Plus Proxy offers Modbus Plus PLC users the chance to integrate the M340 and M580 PLCs easily into their Modbus Plus network and thus to access advanced communications via Ethernet, or to migrate gradually from other PLC models to Modicon M340/M580 and Unity.

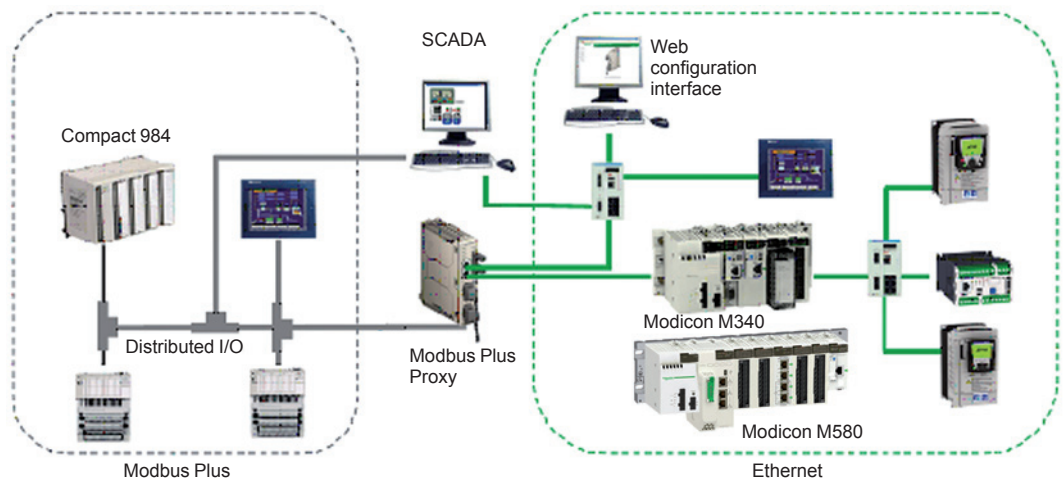

### Key benefits

#### Reduced startup time

- Online configuration of the proxy via a simple Web browser
- Setup Web pages similar to the screens of the Modbus Plus Peer Cop utility, accessible under Concept/Unity for the Global Data transaction
- Simpler data exchange with Global Data transactions performed on all network nodes
- Point-to-point communication without programming with Peer Cop

#### Increased network reliability and maintainability

- Standard diagnostics provide data on all network nodes for easy troubleshooting
- Dual Modbus Plus ports provide Modbus Plus network redundancy

#### Reduced total cost of ownership

- Helps protect your investment in Modbus Plus while migrating to Ethernet
- Dual Ethernet ports allow connection of both the M340 or M580 PLC and the configuration PC to the proxy, without any additional switches

# Modicon M340 automation platform

## Modbus Plus Proxy module

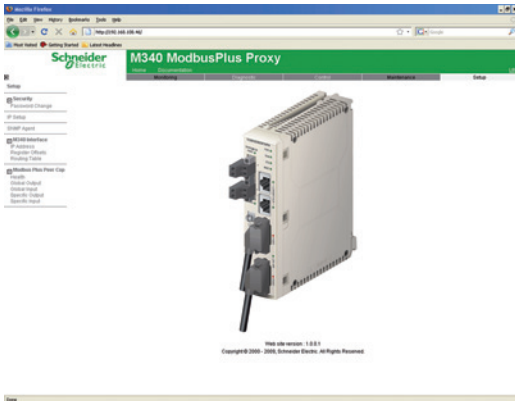

### Embedded Web server

#### Web server functions

The Modbus Plus Proxy module includes an embedded Web server that can be used to perform diagnostics and configure the module connection. All data is presented in the form of standard Web pages in HTML format. To access a Web page, you need Internet Explorer (version 6.0 or later) and Java (version 1.5 or later).

#### Embedded Web server functions

- 1 - Setup: The Setup pages allow you to define the parameters for several different module services, including security, IP, SNMP, Global Data, Peer Cop and Ethernet ports.
- 2 - Diagnostics: These network diagnostic pages contain Ethernet, TCP, and SNMP statistics, as well as a log of the diagnostics performed.

### Complementary characteristics

The following characteristics complement those introduced in the communication selection guide on page 2/6:

- External power supply voltage: 19.2...31.2 V  $\overline{\text{---}}$
- Consumption: 300 mA max.
- Dissipated power: 6.2 W
- Conformity with standards: UL 508, CSA 22.2 No. 142 (cUL), EMI EN 55011, EN 61131-2, C-Tick

### References

#### System and network requirements

- Unity Pro XL programming software (version 3.x or later) (1)
- Internet Explorer (version 6.0 or later)
- Java (version 1.5 or later)
- Microsoft Windows XP or Vista

#### Modicon M340 processors:

- BMXP342020 (Modbus and Ethernet version)
- BMXP3420302 (CANopen and Ethernet version)
- BMXP3420302CL (CANopen and Ethernet version) (2)

#### Modicon M580 processors:

- BMEP581020
- BMEP582020
- BMEP582040
- BMEP583020
- BMEP583040
- BMEP584020
- BMEP584040

#### Ethernet Modicon M340 communication modules:

- BMXNOE0100
- BMXNOE0110
- BMXNOC0401

#### Modicon M580:

- BMENOC03●1

#### Modicon Modbus Plus Proxy module

Description	Type	Reference	Weight kg/ lb
Modbus Plus Proxy module for Modicon M340 and M580 PLCs	Standard	TCSEGDB23F24FA	—
supplied with 2 front-mounted power supply connectors (2 positions)	Conformal coating	TCSEGDB23F24FK	—

(1) Unity V8.0 or later with M580

(2) Memory card to be ordered separately for the **BMXP3420302CL** processor (see our website [www.schneider-electric.com](http://www.schneider-electric.com)).



TCSEGDB23F24FA

# Modicon M340 automation platform

## Profibus DP V1 and Profibus PA buses

### Profibus Remote Master module

2

#### Profibus DP fieldbus

Profibus DP is one of the most widely used fieldbuses in industry. Based on a master/slave protocol, only master stations, sometimes called active stations, have the right to access the bus, with slave, or passive, stations being limited to responding to interrogations.

Version V0 of Profibus only allows cyclic exchanges with I/O, whereas version V1 offers an acyclic message handling channel that can be used for device adjustment or diagnostics during operation.

The physical link is a single shielded twisted pair, but numerous interfaces are available for creating all sorts of topologies - tree, star, or ring - including those using optical fiber or a non-physical link.

Gateways can be used to communicate transparently with Profibus PA, one of the most commonly used standards in process applications for connecting instrumentation. Profibus PA can be used to supply devices across the network and also to install sensors in potentially explosive zones (ATEX).

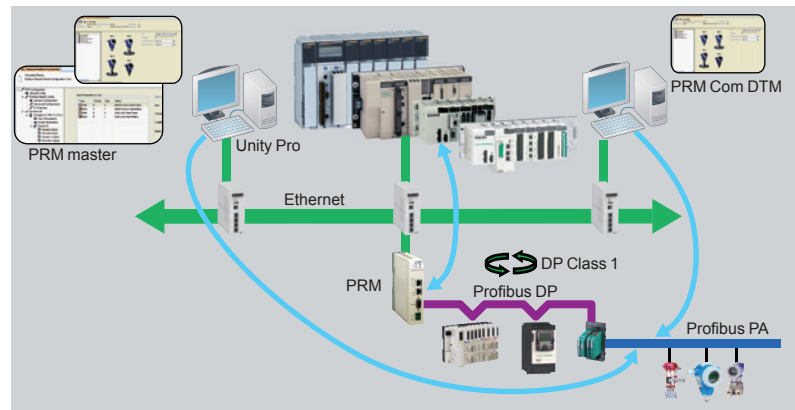

#### Profibus Remote Master (PRM) module

##### Presentation

The Profibus Remote Master (PRM) module is connected to the Ethernet Modbus TCP/IP network via its integrated 2-port switch, as close as possible to the process and the instrumentation.

The PRM module can be used to connect Modicon Quantum, Premium, M580, and M340 PLCs to Profibus DP V1 via the I/O scanner function. Irrespective of the type of PLC, only one product reference is required and setup is identical, thus reducing training and maintenance costs.

Two versions are available, standard and tropicalized, so as to adapt to any type of environment.

The PRM module is open to Asset Management tools. A dedicated communication DTM is supplied with the product, thus allowing any compatible FDT standard tool to remotely adjust devices on Profibus using Ethernet.

##### Configuration

From a single Unity tool, the user can create the Profibus configuration, the PLC application, and configure or calibrate devices.

The latter are integrated in the Unity catalog via their DTMs if they exist, or their *gsd* files.

The I/O scanner configuration is created implicitly in Unity Pro using the Profibus configuration. The parameters assigned by default help optimize performance, as well as the consistency of I/O data in the PLC application, irrespective of the PLC platform.

Similarly, the I/O variables defined and presymbolized in the DTMs can be used directly in the application. Finally, the screens integrated in Unity Pro, together with the diagnostic functions integrated in the device DTMs simplify application maintenance.

# Modicon M340 automation platform

## Profibus DP V1 and Profibus PA buses

### Profibus Remote Master module

#### Profibus Remote Master (PRM) module (continued)

##### Connectable devices

The following Schneider Electric devices can be connected to this bus:

- TeSys U and TeSys T starter-controllers
- Momentum and Modicon STB distributed I/O
- Altivar 312/61/71 variable speed drives for asynchronous motors
- Lexium 05 and 32 servo drives for brushless motors
- Altistart ATS 48 soft start-soft stop units
- LMC Packdrive 3
- Osicoder
- Any third-party device compatible with Profibus DP and PA standard profiles

##### Limitations

Once saved, the Unity project incorporates all the Profibus parameters as well as those of the slaves connected to the bus. Modicon Quantum, Premium, M580, and M340 PLCs are capable of embedding all this data so that an empty Unity terminal without any applications is able, after a simple transfer from the PLC, to locate the whole application, including the slave parameters. This function is called ETS (*Empty Terminal Service*).

In certain cases, it may be that the memory size required to save the device parameters exceeds the PLC memory capacity (signaled by a "memory full" message during the build). This is particularly likely on devices which have DTM (the most common instrumentation on PA). Typically, each device of this type takes up around 20 KB of the PLC memory.

It is therefore essential to create a memory map according to the type of configuration used and possibly adapt it accordingly, either by increasing the amount of memory dedicated to the application (by reducing the zone allocated to data), or by increasing the overall memory via cartridges available in the catalog.

If the ETS function is not required, Unity Pro can also be configured in such a way as to reduce the size of the embedded data by disabling comments and animation tables, or by disabling the upload function so that the application does not include data relating to DTMs. In this case, the upload from an empty terminal function is no longer available.

#### References

The Profibus Remote Master module is supplied with a CD-ROM, which includes:

- The PRM master DTM for operating the PRM on Quantum, Premium, or M340 starting from Unity V5.0
- The PRM Gateway DTM for operating the PRM on M580 starting from Unity V8.0
- The generic Profibus DTM for managing devices not provided with DTM but just with gsd files
- The PRM communication DTM providing total communication transparency from any FDT tool (out of Unity) up to the Profibus devices
- A library of DFBs for PRM management or support of explicit DP V1 communication with Profibus slaves
- PRM technical documentation

#### Profibus Remote Master modules

Description	Type	Reference	Weight kg/lb
Profibus Remote Master modules	Standard	TCSEGA23F14F	0.620/ 1.367
	Ruggedized (1)	TCSEGA23F14FK	0.620/ 1.367

#### Profibus DP bus connection components

Description	Type	Reference	Weight kg/lb
Distributed I/O on Profibus DP bus	Modicon STB network interface module	STBNDP2212	0.140/ 0.309
	Momentum communication module	170DNT11000	0.070/ 0.154
Connectors for remote I/O communication module	Line terminators	490NAD91103	–
	In-line connector	490NAD91104	–
	In-line connector	490NAD91105	–

Description	Length	Reference	Weight kg/lb
Profibus DP connection cables	100 m/328.08 ft	TSXPBSCA100	–
	400 m/1,312.33 ft	TSXPBSCA400	–

(1) Conformal coating and extended operating temperatures between - 25 and + 70 °C/ - 13 and 158 °F (see ruggedized module characteristics, page 3/2)



TCSEGA23F14F



490NAD91103



# Modicon M340 automation platform

## CANopen machine and installation bus

2

### Presentation

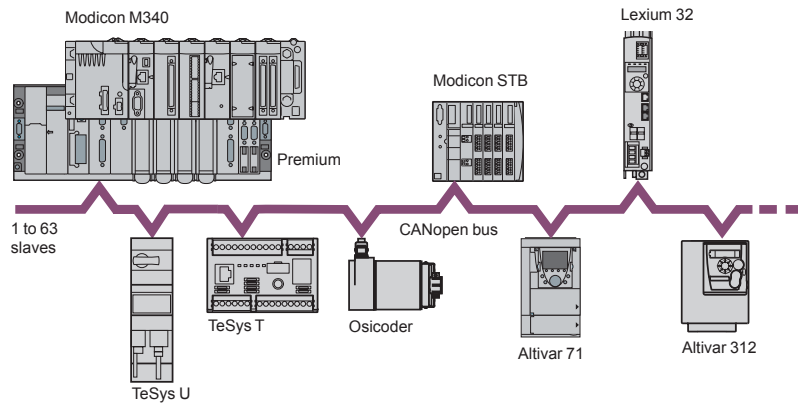

Schneider Electric has selected CANopen for its machines and installations because of its wealth of functions and its resulting benefits in the automation world. This decision was based on the general acceptance of CANopen, and the fact that CANopen products are increasingly used in control system architectures. CANopen is an open network supported by more than 400 companies worldwide, and promoted by CAN in Automation (CiA). CANopen conforms to standards EN 50325-4 and ISO 15745-2. Schneider Electric is heavily involved in working groups, which are important for machine and installation architectures, systems and products.

### CANopen brings transparency to Ethernet

CAN in Automation and Modbus-IDA have worked together to create a standard that ensures total transparency between CANopen and Modbus/TCP. The result of this collaboration has been the CiA DSP309-2 specification, which defines the communication standards between a Modbus/TCP network and a CANopen bus. The specification defines the mapping services which enable CANopen devices to communicate with a Modbus/TCP network through a gateway. The data in a CANopen device can be accessed in both read and write mode.

This specification is the first standard available for developing open standard communication between Modbus/TCP and CANopen. It is driving Schneider Electric network solutions toward better integration, diagnostics and configuration of distributed applications. It allows machines and installations to be connected to an Ethernet network continuously, while combining the advantages of each network in its specific area.

The CANopen bus is a multi-master bus which ensures reliable, deterministic access to real-time data in control system devices. The CSMA/CA protocol is based on broadcast exchanges, sent cyclically or on an event, to ensure optimum use of the bandwidth. A message handling channel can also be used to define slave parameters.

The bus uses a double shielded twisted pair on which, with the Modicon M340 platform, a maximum of 63 devices are connected by daisy-chaining or by tap junctions. The variable data rate between 20 Kbps and 1 Mbps depends on the length of the bus (between 2500 m and 200 m/8202 and 66 ft). Each end of the bus must be fitted with a line terminator.

The Modicon M340 automation platform, via its **BMXP3420102/20302/20102CL/20302CL** processor with integrated CANopen link, performs the role of master on the bus.

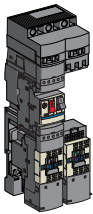

TeSys Quickfit



Altivar ATV 312



Lexium 32



Modicon OTB

### Connectable Schneider Electric devices

The following Schneider Electric devices can be connected to the CANopen bus, depending on the model (1):

- Osicoder absolute encoders
- TeSys U starter-controllers with **LULC08** communication module
- TeSys T motor management system, with LTM controller
- TeSys D motor-starters using the TeSys Quickfit installation help system with **APP1CC00/O2** communication module
- Modicon OTB IP 20 distributed I/O, with Twido I/O expansion modules and OTB interface module
- Modicon STB IP 20 modular distributed I/O, with STB NIM interface module
- Preventa configurable safety controllers
- 0.18...15 kW Altivar 312/71/61 variable speed drives for asynchronous motors:
- Lexium 32 servo drives for BMH and BSH servo motors
- IclLA intelligent compact motor-drives

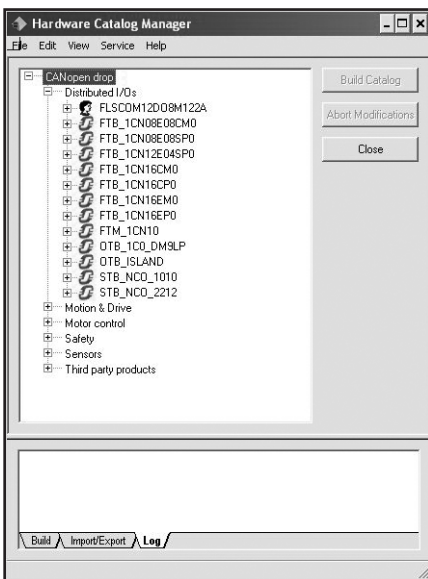

Hardware Catalog Manager for integration of third-party devices

### Integration of third-party devices

■ **Unity Pro version ≥ 4.0** offers the *Hardware Catalog Manager* tool which can be used to integrate third-party devices at an identical level to that of Schneider Electric devices. These third-party devices and their EDS file must conform to the CiA (*CAN In Automation*) standard.

The *Hardware Catalog Manager* tool is used to:

- Integrate third-party devices in Unity Pro
- Optimize the size of the **BMXP3420102/20302/20102CL/20302CL** processor memory area reserved for PDO (*Process Data Object*) process variables
- Customize the parameters specific to each third-party device
- **Unity Pro version ≥ 4.1**, combined with **BMXP3420102/20302/20102CL/20302CL** processors with integrated CANopen link, can be used to customize configuration of the device *Boot Up* procedure, and thus be compatible with all commercially-available CANopen third-party products.

(1) See our website [schneider-electric.com](http://schneider-electric.com) for compatible device versions and their setup software.

# Modicon M340 automation platform

## CANopen machine and installation bus

2

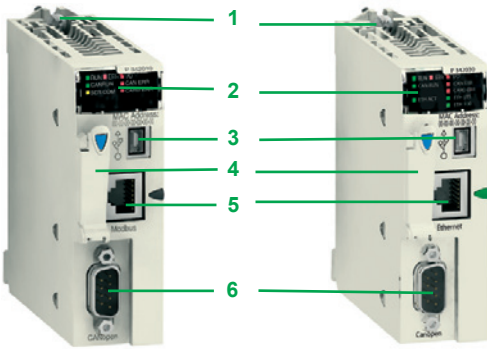

BMXP3420102  
BMXP3420102CL

BMXP3420302  
BMXP3420302CL

### Description

**BMXP3420102/20102CL** and **BMXP3420302/20302CL** Performance processors on the Modicon M340 platform have an integrated CANopen communication port. They feature the following on the front panel:

- 1 A safety screw for locking the module in its slot in the rack, marked "00".
- 2 A display block comprising at least:
  - CAN RUN LED (green): Integrated machine/installation bus operational
  - CAN ERR LED (red): Integrated machine/installation bus fault
- 3 A mini B USB connector for a programming terminal
- 4 A slot equipped with Flash memory card for backing up the application (1)
- 5 An RJ45 connector for serial link (with **BMXP3420102/20102CL** model) or Ethernet Modbus/TCP port (with **BMXP3420302/20302CL** model)
- 6 A 9-way SUB-D connector for the CANopen master machine and installation bus

### Complementary characteristics

The following characteristics complement those introduced in the communication selection guide on page 2/4:

- Data rate: 20 Kbps to 1 Mbps
- Maximum length of CANopen bus (2):
  - 20 m/65.62 ft at 1 Mbps, 40 m/131.23 ft at 800 Kbps, 100 m/328.08 ft at 500 Kbps, 250 m/820.21 ft at 250 Kbps
  - 500 m/1640.42 ft at 125 Kbps, 1000 m/3280.83 ft at 50 Kbps, 2500 m/8202.08 ft at 20 Kbps
- Maximum length of tap-offs on one tap junction (3):
  - 0.6 m/1.97 ft at 1 Mbps, 6 m/19.68 ft at 800 Kbps, 10 m/32.81 ft at 500 Kbps, 10 m/32.81 ft at 250 Kbps
  - 10 m/32.81 ft at 125 Kbps, 120 m/393.70 ft at 50 Kbps, 300 m/984.25 ft at 20 Kbps
- Limitation per segment:
  - Max. number of products: 64 at 1 Mbps, 32 at 800 Kbps, 16 at 500 Kbps
  - Maximum length of segment (4): 160 m/524.93 ft at 1 Mbps, 185 m/606.95 ft at 800 Kbps, 205 m/672.57 ft at 500 Kbps

### Modicon M340 Performance processors with integrated CANopen bus link

Modicon M340 processor modules are supplied with the Flash card **BMXRMS008MP** (1).

This card performs the following actions transparently:

- Backing up the application (program, symbols and constants) supported in the processor internal RAM that is not backed up
- Activation of the Transparent Ready class B10 standard web server (with **BMXP3420302/20302CL** processor)
- This card can be replaced by another card featuring a file storage option (see page 1/13).



BMXP3420102  
BMXP3420102CL



BMXP3420302  
BMXP3420302CL

Capacitance	Max. no. of network/ bus modules	Integrated communication ports	Compatibility with Unity software (5)	Reference	Weight kg/ lb
<b>Performance BMXP3420, 4 racks</b>					
1024 discrete I/O 256 analog I/O 36 application-specific channels 4096 KB integrated	2 Ethernet Modbus/ TCP networks 4 AS-Interface buses	CANopen bus	Version ≥ 4.1	<b>BMXP3420102</b>	0.210/
		Modbus serial link		<b>BMXP3420102CL (1)</b>	0.463
		CANopen bus	Version ≥ 4.1	<b>BMXP3420302</b>	0.215/
		Ethernet network		<b>BMXP3420302CL (1)</b>	0.474
		Modbus/TCP			

(1) Memory card must be ordered separately for the **BMXP3420102CL/302CL** processors (see page 1/13).

(2) Deduct 15 m/49.21 ft per repeater from the length of the bus.

(3) For other restrictions, please refer to the CANopen hardware setup manual available on our website [www.schneider-electric.com](http://www.schneider-electric.com).

(4) With the use of **TSXCANC•50/100/300** CANopen cables and **TSXCANC•DD03/1/3/5** preformed cordsets.

(5) See "Integration of third-party devices" paragraph on page 2/31.

**CANopen bus cabling system**

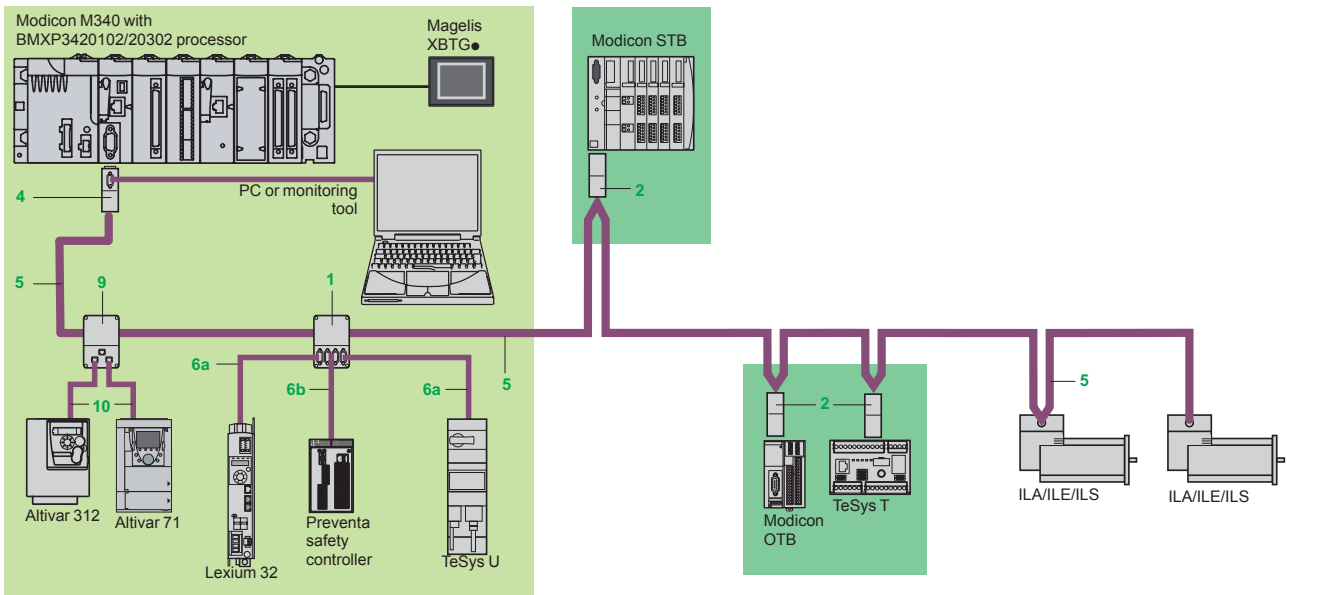

**Note:** For key and references 1, 2, ..., 17, see pages 2/34 to 2/37.

Different types of cable are available, making it possible to create any type of application, including for harsh environments (for a definition of standard and harsh environments, see page 2/34).

Several connectors are available to meet any requirement: straight or 90° angled connectors, or angled connectors with the option of connecting a PC or diagnostic pocket PC.

Power can be supplied to devices by means of cables, cordsets and tap junctions: one AWG24 pair for the CAN signals, one AWG22 pair for the power supply and the ground.

In addition to the IP 20 cabling offer, there is also an IP 67 cabling offer.

# Modicon M340 automation platform

## CANopen machine and installation bus Cabling system

2



TSXCANTDM4

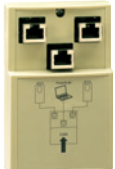

VW3CANTAP2



TSXCANKCDF90T



TSXCANKCDF180T



TSXCANKCDF90TP

### Standard tap junctions and connectors

Designation	Description	No. (1)	Reference	Weight kg/lb
<b>IP 20 CANopen tap junction</b>	4 SUB-D ports. Screw terminal block for connecting the trunk cables Line termination	1	TSXCANTDM4	0.196/ 0.432
<b>IP 20 connectors</b> CANopen female 9-way SUB-D. Switch for line termination	90° angled	2	TSXCANKCDF90T	0.046/ 0.101
	Straight (2)	–	TSXCANKCDF180T	0.049/ 0.108
	Right angle with 9-way SUB-D for connecting a PC or diagnostic tool	4	TSXCANKCDF90TP	0.051/ 0.112
<b>IP 67 M12 connectors</b>	Male	–	FTXCN12M5	0.050/ 0.110
	Female	–	FTXCN12F5	0.050/ 0.110
<b>IP 20 CANopen tap junctions</b> for Altivar and Lexium 32	2 RJ45 ports	9	VW3CANTAP2	–

### IP 20 standard cables and preformed cordsets

Designation	Description	No. (1)	Length m/ft	Unit reference	Weight kg/lb
<b>CANopen cables</b> (AWG 24)	Standard, CE marking: low smoke emission. Zero halogen. Flame-retardant (IEC 60332-1)	5	50/	TSXCANCA50	4.930/
			164.04	TSXCANCA100	8.800/
			328.08	TSXCANCA300	24.560/
			984.25		54.145
	Standard, UL certification, CE marking: flame-retardant (IEC 60332-2)	5	50/	TSXCANCB50	3.580/
			164.04	TSXCANCB100	7.893
			328.08	TSXCANCB300	21.870/
			984.25		48.215
	For harsh environments (3) or mobile installations, CE marking: low smoke emission. Zero halogen. Flame-retardant (IEC 60332-1). Oil-resistant	5	50/	TSXCANCD50	3.510/
			164.04	TSXCANCD100	7.770/
			328.08	TSXCANCD300	21.700/
			984.25		47.840
<b>CANopen preformed cordsets</b> One 9-way female SUB-D connector at each end (AWG 24)	Standard, CE marking: low smoke emission. Zero halogen. Flame-retardant (IEC 60332-1)	6a	0.3/	TSXCANCADD03	0.091/
			0.98	TSXCANCADD1	0.201
			1/	TSXCANCADD3	0.143/
			3.28		0.315
			9.84	TSXCANCADD3	0.295/
			16.40	TSXCANCADD5	0.650/
			16.40		0.440/
					0.970
	Standard, UL certification, CE marking: flame-retardant (IEC 60332-2)	6a	0.3/	TSXCANCBDD03	0.086/
			0.98	TSXCANCBDD1	0.190
			1/	TSXCANCBDD3	0.131/
			3.28		0.289
			9.84	TSXCANCBDD3	0.268/
			16.40	TSXCANCBDD5	0.591/
			16.40		0.400/
					0.882

(1) For key to numbers, see page 2/33.

(2) For connection to Controller Inside programmable card, the VW3CANKCDF180T connector can also be used.

(3) **Standard environment:**

- Without any particular environmental constraints
- Operating temperature between + 5°C/41°F and + 60°C/140°F
- Fixed installation

**Harsh environment:**

- Resistance to hydrocarbons, industrial oils, detergents, solder splashes
- Relative humidity up to 100%
- Saline atmosphere
- Significant temperature variations
- Operating temperature between - 10°C/14°F and + 70°C/158°F
- Mobile installation

(4) Cordset with line termination.

# Modicon M340 automation platform

## CANopen machine and installation bus Cabling system

IP 20 standard cables and preformed cordsets (continued)					
Designation	Description	No. (1)	Length m/ ft	Unit reference	Weight kg/ lb
CANopen preformed cordsets	One 9-way SUB-D connector, One RJ45 connector (AWG 24)	6b	0.5/ 1.64	TCSCCN4F3M05T	—
			1/ 3.28	TCSCCN4F3M1T	—
				VW3M3805R010 (2)	—
			3/ 9.84	TCSCCN4F3M3T	—
					—
	Two 9-way SUB-D connectors, one male and one female	—	0.5/ 1.64	TLACDCBA005	—
			1.5/ 4.92	TLACDCBA015	—
			3/ 9.84	TLACDCBA030	—
			5/ 16.40	TLACDCBA050	—
					—
IP 67 standard preformed cordsets					
Designation	Description	No. (1)	Length m/ ft	Unit reference	Weight kg/ lb
CANopen preformed cordsets	Preformed cordsets of two 5-way M12 A-coded angled connectors (one male connector and one female connector)	12	0.3/ 0.98	FTXCN3203	0.40/ 0.881
			0.6/ 1.97	FTXCN3206	0.70/ 1.543
			1/ 3.28	FTXCN3210	0.100/ 0.220
			2/ 6.56	FTXCN3220	0.160/ 0.353
			3/ 9.84	FTXCN3230	0.220/ 0.485
			5/ 16.40	FTXCN3250	0.430/ 0.948

(1) For key to numbers, see page 2/33.

(2) Cordset with line termination.

# Modicon M340 automation platform

## CANopen machine and installation bus Cabling system

2



VW3CANA71

### IP 20 connection accessories

Designation	Description	No. (1)	Length m/ft	Reference	Weight kg/lb
<b>CANopen connector</b> for Altivar 71 drive (2)	9-way female SUB-D. Switch for line termination. Cables exit at 180°	–	–	<b>VW3CANKCDF180T</b>	–
<b>Adaptor</b> for Altivar 71 drive	SUB-D to RJ45 CANopen adaptor	–	–	<b>VW3CANA71</b>	–
<b>Preformed CANopen cordsets</b> for Altivar drives	One RJ45 connector at each end	10	0.3/0.98	<b>VW3CANCARR03</b>	–
			1/3.28	<b>VW3CANCARR1</b>	–
<b>Y-connector</b>	CANopen/Modbus	–	–	<b>TC SCTN011M11F</b>	–

### IP 67 connection accessories

#### For Modicon FTB monobloc splitter boxes

Designation	Composition	No. (1)	Length m/ft	Reference	Weight kg/lb	
<b>IP 67 line terminator</b>	Equipped with one M12 connector (for end of bus)	13	–	<b>FTXCNTL12</b>	0.010/ 0.022	
<b>24 V ~ power supply connection cables</b>	Equipped with two 5-way 7/8 connectors	16	0.6/1.97	<b>FTXDP2206</b>	0.150/ 0.331	
			1/3.28	<b>FTXDP2210</b>	0.190/ 0.419	
			2/6.56	<b>FTXDP2220</b>	0.310/ 0.683	
			5/16.40	<b>FTXDP2250</b>	0.750/ 1.653	
			Equipped with one 5-way 7/8 connector at one end and flying leads at the other end	1.5/4.92	<b>FTXDP2115</b>	0.240/ 0.529
				3/9.84	<b>FTXDP2130</b>	0.430/ 0.948
5/16.40	<b>FTXDP2150</b>	0.700/ 1.543				
<b>T-connector</b> for power supply	Equipped with two 5-way 7/8 connectors	–	–	<b>FTXCNT1</b>	0.100/ 0.220	



FTXDP21●●

(1) For key to numbers, see page 2/33.

(2) For **ATV71H●●●M3**, **ATV71HD11M3X**, **HD15M3X**, **ATV71H075N4 ... HD18N4** drives, this connector can be replaced by the **TSXCANKCDF180T** connector.

## IP 67 connection accessories (continued)

### Separate parts

Designation	Composition		Sold in lots of	Reference	Weight kg/lb
<b>Connectors</b>	7/8 type, 5-way	Male	–	<b>FTXC78M5</b>	0.050/ 0.110
		Female	–	<b>FTXC78F5</b>	0.050/ 0.110
	Straight, M12 type, 5 screw terminals	Male	–	<b>XZCC12MDM50B</b>	0.020/ 0.044
		Female	–	<b>XZCC12FDM50B</b>	0.020/ 0.044
	Angled, M12 type, 5 screw terminals	Male	–	<b>XZCC12MCM50B</b>	0.020/ 0.044
		Female	–	<b>XZCC12FCM50B</b>	0.020/ 0.044
<b>Sealing plugs</b>	For M8 connector (sold in packs of 10)		–	<b>FTXCM08B</b>	0.100/ 0.220
	For M12 connector (sold in packs of 10)		–	<b>FTXCM12B</b>	0.100/ 0.220
	For 7/8 connector		–	<b>FTXC78B</b>	0.020/ 0.044
<b>Y-connectors</b>	Connection of two M8 connectors to M12 connector on splitter box		–	<b>FTXCY1208</b>	0.020/ 0.044
	Connection of two M12 connectors to M12 connector on splitter box		–	<b>FTXCY1212</b>	0.030/ 0.066
<b>Diagnostics adaptor</b>	Equipped with two M12 connectors		–	<b>FTXDG12</b>	0.020/ 0.044
<b>Marker labels</b>	For plastic splitter boxes		10	<b>FTXBLA10</b>	0.010/ 0.022
	For metal splitter boxes		10	<b>FTXMLA10</b>	0.010/ 0.022

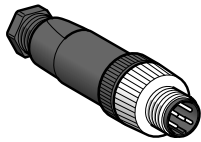

XZCC12DM50B

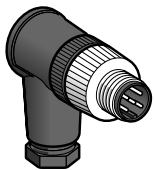

XZCC12CM50B



FTXCY1208



### Presentation

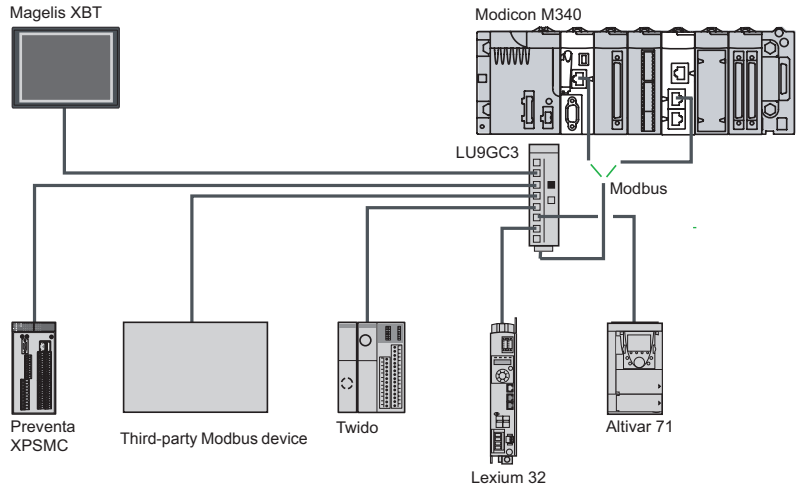

The Modbus serial link is used for master/slave architectures (it is necessary, however, to check that the Modbus services used by the application have been implemented on all relevant devices).

The bus consists of a master station and slave stations. Only the master station can initiate the exchange (direct communication between slave stations is not possible). Two exchange mechanisms are available:

- Question/response, where requests from the master are addressed to a given slave. The master then waits for the response from the slave which has been interrogated.
- Broadcasting, where the master broadcasts a message to all slave stations on the bus. The latter execute the order without transmitting a reply.

The Modicon M340 platform offers serial link connection options for Modbus or Character mode:

- Via the serial link integrated in the following processors:
  - Standard processor **BMXP341000**
  - Performance processors **BMXP342000/20102/2020/20102CL**

The number of serial link modules is limited by the maximum number of application-specific channels permitted per station, depending on the type of processor:

- Standard processor **BMXP341000**: maximum of 20 application-specific channels (1).
- Performance processors **BMXP342●●●●**: maximum of 36 application-specific channels (1).

### Description

#### Processors with integrated serial link

**BMXP341000/2000/20102/2020/20102CL** processors integrate a serial link which can be used with either the Modbus RTU/ASCII master/slave protocol or with the Character mode protocol.

These processors have the following elements on the front panel, relating to the serial port:

- 1 A display block including at least the following LEDs:
  - SER COM LED (yellow): Activity on the serial link (lit) or fault on a device present on the serial link (flashing).
- 2 An RJ45 connector for Modbus serial link or Character mode link (non-isolated RS 232C/RS 485) with its black indicator (2).

**Note:** For more information about the processors, see page 1/11

(1) Application-specific channels: **BMXEHC0200** counter modules (2 channels), **BMXEHC0800** (8 channels), **BMXMSP0200** motion control modules (2 channels) and **BMXNOR0200H** RTU communication module (1 channel).

(2) For isolated serial links, the **TWDXCAISO** isolation box must be used.

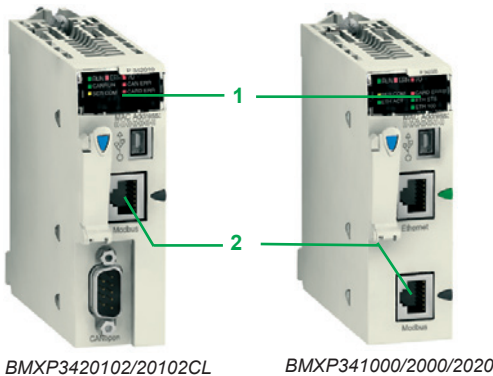

BMXP3420102/20102CL

BMXP341000/2000/2020

### Complementary characteristics

The following characteristics complement those indicated in the selection guide on page 2/5.

#### Serial link integrated in the processors

- Physical interface:
  - In Modbus: RS 232 4-wire or RS 485 2-wire, non-isolated (1)
  - In Character mode: RS 232 4-wire or RS 485 2-wire
- Frame:
  - In Modbus: RTU/ASCII half duplex
  - In Character mode: full duplex in RS 232, half duplex in RS 485
- Maximum length of a tap link in RS 485 2-wire:
  - 15 m/49.21 ft in a non-isolated serial link
  - 40 m/131.23 ft in an isolated serial link (1)

### References

I/O capacity	Memory capacity	Integrated communication ports	Reference	Weight kg/lb
<b>BMX P3410 Standard processor with integrated serial link, 2 racks</b>				
512 discrete I/O 128 analog I/O 20 application-specific channels	2048 KB integrated	Modbus serial link	<b>BMXP341000</b>	0.200/ 0.441

#### BMX P3420 Performance processors with integrated serial link, 4 racks

1024 discrete I/O 256 analog I/O 36 application-specific channels	4096 KB integrated	Modbus serial link	<b>BMXP342000</b>	0.200/ 0.441
		Modbus serial link CANopen bus	<b>BMXP342010</b>	0.210/ 0.463
		Modbus serial link CANopen bus version V2.1 (2)	<b>BMXP3420102</b> <b>BMXP3420102CL (3)</b>	0.210/ 0.463 0.210/ 0.463
		Modbus serial link Ethernet Modbus/TCP network	<b>BMXP342020</b>	0.205/ 0.452



BMXP341000/2000



BMXP342020

(1) For isolated serial links, the **TWDXCAISO** isolation box must be used.

(2) Version which can be used to customize configuration of the device Boot Up procedure compatible with all third-party CANopen products. Requires Unity Pro version V4.1.

(3) Memory card must be ordered separately for the **BMXP3420102CL** processor (see page 1/13).

#### Cabling system

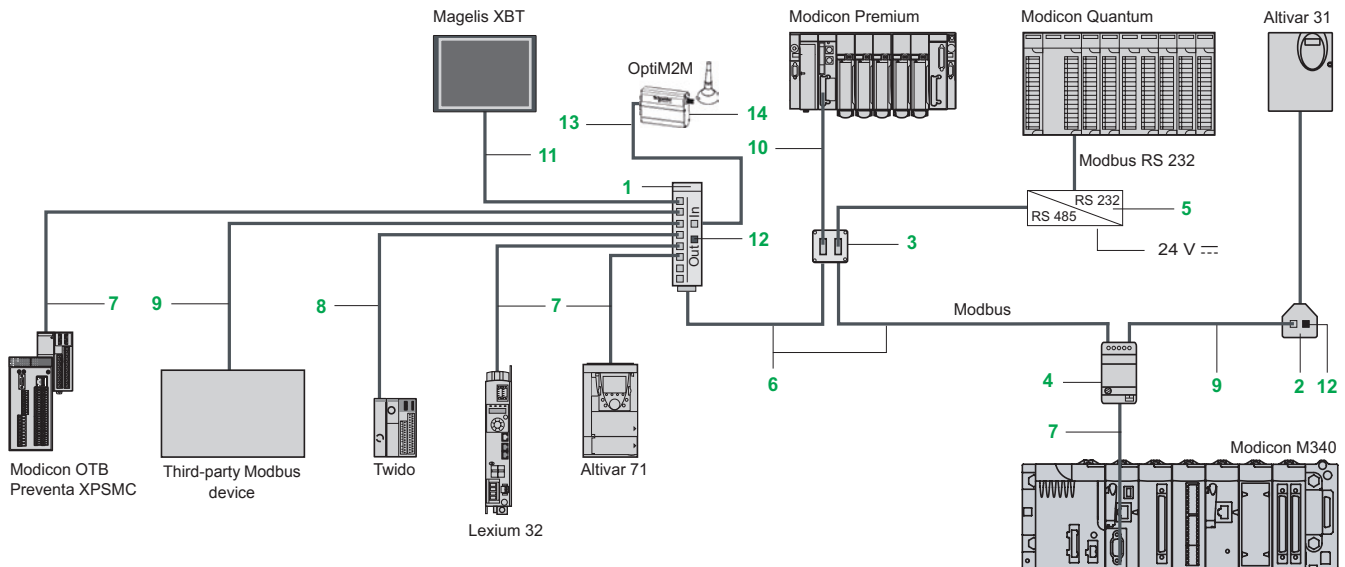

#### Extension and adaptation elements for RS 485 serial link



LU9GC3



VW3A8306TF03



TWDXCAISO

TWDXCAT3RJ



VW3A8114



XGSZ24

Designation	Description	No.	Length m/ ft	Unit reference	Weight kg/ lb
<b>Modbus splitter box</b>	- 1 screw terminal block for trunk cable: D(A), D(B), $\bar{\text{0V}}$ and 0V - 8 x RJ45 connectors for tap-off - 2 x RJ45 connectors for series connection of LU9 GC3 splitter boxes Mounting on 35 mm/1.38 in. $\perp$ rail	1	–	LU9GC3	0.500/ 1.102
<b>T-junction boxes</b> dedicated to Altivar and Lexium	- 2 x RJ45 connectors - 1 integrated cable with RJ45 connector	2	0.3/ 0.98 1/ 3.28	VW3A8306TF03 VW3A8306TF10	0.190/ 0.419 0.210/ 0.463
<b>Passive T-junction box</b>	- Tap-off and extension of the bus - Line termination	–	–	TSXSACA50	0.520/ 1.146
<b>2-channel passive subscriber socket</b>	- 2-channel tap-off point and extension of trunk cable - Address coding SUB-D connectors and 2 screw terminal blocks	3	–	TSXSACA62	0.570/ 1.257
<b>Junction box</b> Screw terminal block for trunk cable tap-off 1 x RJ45 connector for tap-off	- Isolation of the RS 485 serial link - Line termination (R = 120 $\Omega$ , C = 1 nF) - Line pre-polarization (1) (2 R = 620 $\Omega$ ) 24 V $\bar{\text{0V}}$ power supply (2) Mounting on 35 mm/1.38 in. $\perp$ rail	4	–	TWDXCAISO	0.100/ 0.220
<b>Tap junction</b> 3 x RJ45 connectors	- Line termination (R = 120 $\Omega$ , C = 1 nF) - Line pre-polarization (1) (2 R = 620 $\Omega$ ) Mounting on 35 mm/1.38 in. $\perp$ rail	–	–	TWDXCAT3RJ	0.080/ 0.176
<b>Modbus/Bluetooth<sup>®</sup> adaptor</b>	- 1 Bluetooth <sup>®</sup> adaptor (range 10 m/0.39 in., class 2) with 1 x RJ45 connector - 1 x 0.1 m/0.004 in. long cordset for PowerSuite with 2 x RJ45 connectors - 1 x 0.1 m/0.004 in. long cordset for TwidoSuite, with 1 x RJ45 connector and 1 mini-DIN connector - 1 RJ45/9-way male SUB-D adaptor for Altivar drives	–	–	VW3A8114	0.155/ 0.342
<b>RS 232C/RS 485 line converter</b> without modem signals	24 V $\bar{\text{0V}}$ /20 mA power supply, 19.2 Kbps Mounting on 35 mm/1.38 in. $\perp$ rail	5	–	XGSZ24	0.100/ 0.220
<b>Line terminator</b>	For RJ45 connector R = 120 $\Omega$ , C = 1 nF	12	Sold in lots of 2	VW3A8306RC	0.200/ 0.441

(1) Line polarization required for connection to the master Twido programmable controller.

(2) 24 V  $\bar{\text{0V}}$  power supply, or power supply via the serial port integrated in Modicon M340 processors.

# Modicon M340 automation platform

## Modbus and Character mode serial link

### Cabling system

#### Cables and cordsets for RS 485 serial link

Designation	Description	No.	Length m/ ft	Unit reference	Weight kg/ lb
<b>RS 485 double shielded twisted pair trunk cables</b>	Modbus serial link, supplied without connector	<b>6</b>	100/ 328.08	<b>TSXCSA100</b>	5.680/ 12.522
			200/ 656.17	<b>TSXCSA200</b>	10.920/ 24.075
		500/ 1640.42	<b>TSXCSA500</b>	30.000/ 66.139	
<b>Modbus RS 485 cordsets</b>	2 x RJ45 connectors	<b>7</b>	0.3/ 0.98	<b>VW3A8306R03</b>	0.030/ 0.066
			1/ 3.28	<b>VW3A8306R10</b>	0.050/ 0.110
			3/ 9.84	<b>VW3A8306R30</b>	0.150/ 0.331
	1 x RJ45 connector and 1 x 15-way SUB-D connector	–	3/ 9.84	<b>VW3A8306</b>	0.150/ 0.331
	1 x mini-DIN connector for Twido controller and 1 x RJ45 connector	<b>8</b>	0.3/ 0.98	<b>TWDXCARJ003</b>	0.040/ 0.088
			1/ 3.28	<b>TWDXCARJ010</b>	0.090/ 0.198
			3/ 9.84	<b>TWDXCARJ030</b>	0.160/ 0.353
	1 x RJ45 connector and 1 end with flying leads	<b>9</b>	3/ 9.84	<b>VW3A8306D30</b>	0.150/ 0.331
	1 miniature connector and 1 x 15-way SUB-D connector	<b>10</b>	3/ 9.84	<b>TSXSPCM4530</b>	0.180/ 0.397
	<b>Cordsets for Magelis XBT display units and terminals</b>	1 x RJ45 connector and 1 x 25-way SUB-D connector for: - XBTN200/N400/NU400 - XBTR410/411 - XBTGT2...GT7 (COM1 port) (1)	<b>11</b>	2.5/ 8.20	<b>XBTZ938</b>
2 x RJ45 connectors for: - XBTGT1 (COM1 port) - XBTGT2...GT7 (COM2 port)				<b>11</b>	3/ 9.84

#### Cordsets for RS 232 serial link

Designation	Description	Length m/ ft	Reference	Weight kg/ lb
<b>Cordset for Data Terminal Equipment (DTE) (printer)</b>	Serial link for DTE (2) 1 x RJ45 connector and 1 x 9-way female SUB-D connector	3/ 9.84	<b>TCSMCN3M4F3C2</b>	0.150/ 0.331
<b>Cordset for Data Communication Equipment (DCE) (modem, converter)</b>	Serial link for DCE 1 x RJ45 connector and 1 x 9-way male SUB-D connector	3/ 9.84	<b>TCSMCN3M4M3S2</b>	0.150/ 0.331

#### OptiM2M

Designation	Description	No.	Length m/ ft	Reference	Weight kg/ lb
<b>Modbus RS485 Cordset (2)</b>	1 x RJ45 connector and 1 x 9-way SUB-D connector	<b>13</b>	3/ 9.84	<b>SERM2MUNI2</b>	–
<b>OptiM2M Pack (3)</b>	The modem with embedded SIM card 35 mm (1.38 in) DIN rail mounting clip 2 mounting brackets Instructions 2-wire cable (red/black) with in-line fuse GSM magnetic antenna (SMA-M) Modbus RS485 cordset	<b>14</b>	3/ 9.84	<b>SERM2MMOD485</b>	–

(1) For use with **XBTZG909** adaptor.

(2) Only compatible with a **OptiM2M** modem.

(3) **OPTIM2M**, the ready to use solution.

**OptiM2M** comprises:

- The **OPTIM2M** pack which connects the machine to the Schneider Cloud via the GPRS network.

- A web application embedded in the Schneider Cloud which allows:

Management of a group of machines or equipment anywhere in the world.

Monitoring and analysis of machine and installation data.

- A subscription, which allows:

Use of the **OptiM2M** portal and services (Hosting, Roaming, Data consumption, Dashboards).



# 3 - Ruggedized Modicon M340 modules

---

## Treatment for severe environments

- Presentation..... page 3/2
- Harsh chemical environments..... page 3/2
- Extreme climatic environments..... page 3/2

## Ruggedized processor modules

- References ..... page 3/3

## Ruggedized communication modules and network gateway

- References ..... page 3/3



# Modicon M340 automation platform

## Treatment for severe environments

### Ruggedized modules



BMXP341000H



BMXP342020H

### Presentation

#### Protective treatment of Modicon M340 PLCs

Modicon M340 PLCs comply with "TC" treatment requirements (Treatment for all Climates). They are designed as standard to operate in temperatures of 0°C/32°F to + 60°C/140°F.

For installations in industrial production workshops or environments corresponding to "TH" (Treatment for Hot and humid environments), PLCs must be housed in enclosures providing at least IP 54 protection as specified by standard IEC/EN 60529, or an equivalent level of protection according to NEMA 250.

Modicon M340 PLCs themselves offer **IP 20 degree of protection** (1). They can therefore be installed without an enclosure in reserved access areas that do not exceed **pollution level 2** (control room with no dust-producing machinery or activity). **Pollution level 2** does not take account of harsher environments, such as those where the air is polluted with dust, fumes, corrosive or radioactive particles, vapours or salts, moulds, insects, etc.

#### Treatment for more severe environments

If the Modicon M340 automation platform has to be used in more severe environments or is required to start and operate in an extended temperature range, from - 25°C/- 13°F to + 70°C/158°F, the "ruggedized" offer features industrially hardened processor and power supply modules, Bus X I/O modules and racks which have protective coating on all their circuit boards.

*Note: Capable of starting within an extended temperature range (from - 25°C/- 13°F to + 70°C/158°F), a single-rack configuration is also able to operate at extremely low temperatures (to - 40°C/- 40°F) if placed in an appropriate enclosure. Please consult our Customer Care Centre.*

This treatment increases the isolation capability of the circuit boards and their resistance to:

- Condensation
- Dusty atmospheres (conducting foreign particles)
- Chemical corrosion, in particular during use in sulphurous atmospheres (oil refinery, purification plant, etc.) or atmospheres containing halogens (chlorine, etc.)

This protection, combined with appropriate installation and maintenance, enables Modicon M340 products to be used in the following environments:

#### ■ Harsh chemical environments:

##### □ IEC/EN 60721-3-3 class 3C3:

- 14 days; 25°C/77°F/relative humidity 75%
- Concentrations (mm<sup>3</sup>/m<sup>3</sup>): H<sub>2</sub>S: 2100/SO<sub>2</sub>: 1850/Cl<sub>2</sub>: 100

##### □ ISA S71.04 classes G1 to G3:

- 14 days; 25°C/77°F/relative humidity 75%
- Concentrations (mm<sup>3</sup>/m<sup>3</sup>): H<sub>2</sub>S: 50/SO<sub>2</sub>: 300/Cl<sub>2</sub>: 10/NO<sub>2</sub>: 1250

##### □ IEC/EN 60068-2-52 salt mist, Kb test severity level 2:

- 3 x 24-hour cycles
- 5% NaCl
- 40°C/104 °F/relative humidity 93%

#### ■ Extreme climatic environments:

- Temperatures from - 25°C/- 13°F to + 70°C/158°F
- Relative humidity levels up to 93% (95% depending on the device), from + 25°C/77°F to + 70°C/158°F during operation
- Formation of ice
- Altitudes from 0 to 5000 m/16,404.15 ft

#### References and characteristics

To order ruggedized modules and racks, see the reference page 3/3 (the references of the ruggedized products available include the suffix "H").

All standard separate parts (cordsets, cables, memory cards, sub-bases, etc.) which are compatible with the ruggedized modules offer are listed in the reference pages (see page 3/3).

The majority of operating and electrical characteristics of ruggedized modules are identical to those of their equivalent standard versions. However, some characteristics are subject to either derating or limitation. Please consult our website [www.schneider-electric.com](http://www.schneider-electric.com).

(1) Each slot in a **BMXXSP●●●0** rack is equipped as standard with a protective cover that should only be removed when inserting a module. If any covers are subsequently misplaced, replacements can be ordered under reference **BMXXEM010** (sold in lots of 5).

# Modicon M340 automation platform

Dedicated parts for severe environments

Ruggedized processors and communication modules



BMXP3420302H



BMXRMS008MPF/128MPF



BMXXCAUSBH0



BMXNOE0100H/0110H



TCSEGA23F14FK

### BMXP34 Modicon M340 ruggedized processors (1)

Modicon M340 processor modules are supplied with the **BMXRMS008MP** Flash memory card. This card performs the following actions transparently:

- Backup of the application (program, symbols and constants) supported in the processor's internal RAM which is not backed up

- Activation of the Transparent Ready class B10 standard Web server with **BMXP341000H** Standard processors and **BMXP342020H/20302H** Performance processors.

This card can be replaced by either of the **BMXRMS008MPF** or **BMXRMS128MPF** cards which feature a file storage option.

Max. capacity	Memory capacity	Max. no. of network modules	Integrated communication ports	Reference	Weight kg/lb
2 racks 512 discrete I/O 128 analog I/O 20 application-specific channels	2048 KB integrated	2 Ethernet networks	Modbus serial link	<b>BMXP341000H</b>	0.200/ 0.441
4 racks 1024 discrete I/O 256 analog I/O 36 application-specific channels	4096 KB integrated	2 Ethernet networks	Modbus serial link Ethernet network	<b>BMXP342020H</b>	0.205/ 0.452
			Ethernet network CANopen bus	<b>BMXP3420302H</b>	0.215/ 0.474

### Standard memory cards

Description	Processor compatibility	Capacity	Reference	Weight kg/lb
Flash memory cards (2)	BMXP342020H	8 MB/8 MB files	<b>BMXRMS008MPF</b>	0.002/ 0.004
	BMXP3420302H	8 MB/128 MB files	<b>BMXRMS128MPF</b>	0.002/ 0.004

### Standard separate parts

Description	Use		Length m/ft	Reference	Weight kg/lb
	From	To			
Terminal port/USB cordsets	Mini B USB port on the Modicon M340 processor	Type A USB port on: - PC terminal - Magelis XBTGT/ GK/GTW, GTWHMI, STU/STOHI graphic terminal	1.8/ 5.91	<b>BMXXCAUSBH018</b>	0.065/ 0.143
			4.5/ 14.76	<b>BMXXCAUSBH045</b>	0.110/ 0.243

### Standard replacement part

Description	Use	Processor compatibility	Reference	Weight kg/lb
8 MB Flash memory card	Supplied as standard with each processor. Used for: - Backing up the program, constants, symbols and data - Activation of class B10 Web server	BMXP342020H BMXP3420302H	<b>BMXRMS008MP</b>	0.002/ 0.004

### Communication

#### BMXNOE0100H/0110H ruggedized Ethernet communication modules

Description	Data rate	Transparent Ready Class	Reference	Weight kg/lb
Ethernet Modbus/TCP network modules	10/100 Mbps	B30	<b>BMXNOE0100H</b>	0.200/ 0.441
		C30	<b>BMXNOE0110H</b>	0.200/ 0.441

#### Ruggedized Profibus DP network gateway

Description	Protocols	Physical layer	Reference	Weight kg/lb
Profibus Remote Master (PRM) module	Modbus TCP	1 Ethernet switch, 2 ports 10BASE-T/100BASE-TX	<b>TCSEGA23F14FK</b>	-
	Profibus DP V1 and Profibus PA (via gateway)	1 isolated RS 485 Profibus DP port		

#### Standard connection accessory

Designation	Description	RS 232 interface	Reference	Weight kg/lb
Cordset for DCE terminal (modem, etc.)	Equipped with 1 x RJ45 connector and 1 x 9-way male SUB-D connector Length 3 m/9.843 ft	Simplified 4-wire (RX, TX, RTS and CTS)	<b>TCSMCN3M4M3S2</b>	0.150/ 0.331
		Full 8-wire (except RI signal)	<b>TCSXCN3M4F3S4</b>	0.165/ 0.364

(1) General characteristics are the same as those of the standard equivalent versions (see page 1/8).

(2) Cards to replace the memory card supplied as standard with each processor, used for:

- Backing up the program, constants, symbols and data
- File storage
- Activation of class B10 Web server





---

## Technical appendices

- Standards, certifications and environmental conditions ..... page 4/2
- Ethernet network infrastructure ..... page 4/6
- Certifications for automation products and EC regulations ..... page 4/12
- Power consumption table and calculation sheet ..... page 4/14

## A dedicated services offer for your installed base

- Operation services ..... page 4/16
- Modernization services ..... page 4/17
- Customization services ..... page 4/17

## Index

- Product reference index ..... page 4/18

### Standards and certifications

Modicon M340 PLCs have been developed to comply with the principal national and international standards concerning electronic equipment for industrial automation systems.

- Requirements specific to programmable controllers: functional characteristics, immunity, resistance, safety, etc.: **IEC/EN 61131-2**, UL and CSA standards for industry (**UL 508**, **CSA E61131-2**).
- Requirements specific to power utility automation system: **IEC/EN 61850-3**.
- Merchant navy requirements of the major international organizations: unified in IACS (International Association of Classification Societies).
- Compliance with European Directives for CE marking:
  - Low Voltage: 2006/95/EC,
  - Electromagnetic Compatibility: 2004/108/EC.
- Ex areas:
  - For USA and Canada: Hazardous location class I, division 2, groups A,B,C and D
  - For other countries: CE ATEX (directive 94/9/EC) or IECEx in defined atmosphere Zone 2 (gas) and/or Zone 22 (dust).
  - Up to date information on which certifications have been obtained are available on our website..

### Characteristics

#### Service conditions and recommendations relating to environment

		M340		M340H			
Temperature	Operation	° C	0...+ 60	- 25...+ 70			
	Storage	° C	- 40...+ 85	- 40...+ 85			
Relative humidity (without condensation)	Cyclical humidity	%	+ 5 ... + 95 up to 55°C	+ 5 ... + 95 up to 55 °C			
	Continuous humidity	%	+ 5 ... + 93 up to 55°C	+ 5 ... + 93 up to 60 °C			
Altitude	Operation	m	0...2000 (full specification: temperature and isolation) 2000 ... 4000 (temperature derating: 1 °C / 400 m, isolation lost: 150 V --- / 1000 m)				
Supply voltage	<b>Modicon X80 I/O power supply modules</b>						
			<b>BMXCPS2010</b>	<b>BMXCPS3020 BMXCPS3020H</b>	<b>BMXCPS3540T</b>	<b>BMXCPS2000</b>	<b>BMXCPS3500 BMXCPS3500H</b>
	Nominal voltage	V	--- 24	--- 24...48	--- 125	~ 100...240	~ 100...240
	Limit voltages	V	--- 18...31.2	--- 18...62.4	--- 100...150	~ 85...264	~ 85...264
	Nominal frequencies	Hz	–	–	–	50/60	50/60
	Limit frequencies	Hz	–	–	–	47/63	47/63

### Protective treatment of Modicon M340 PLCs

Modicon M340 PLCs meet the requirements of "TC" treatment (*Treatment for all Climates*).

For installations in industrial production workshops or environments corresponding to "TH" treatment (*treatment for hot and humid environments*), Modicon M340 PLCs must be embedded in envelopes with a minimum IP 54 protection.

Modicon M340 PLCs themselves offer **protection to IP 20 level** and **protection against pins** (enclosed equipment) (1). They can therefore be installed without an envelope in reserved-access areas which do not exceed **pollution level 2** (control room with no dust-producing machine or activity). The pollution level 2 does not take account of more severe environmental conditions: air pollution by dust, smoke, corrosive or radioactive particles, vapours or salts, attack by fungi, insects, ...

(1) In the case where a position is not occupied by a module, a **BMXXEM010** protection cover must be installed.

(CE): tests required by European directives (CE) and based on IEC/EN 61131-2 standards.

Environment tests		
Name of test	Standards	Levels
<b>Immunity to LF interference (CC) (1)</b>		
Voltage and frequency variations	IEC/EN 61131-2; IEC/EN 61000-6-2; IEC 61000-4-11 IACS E10; IEC 61000-4-11	0.85...1.10 Un - 0.94...1.04 Fn; 4 steps t = 30 min 0.80 Un...0.90 Fn; 1.20 Un...1.10 Fn; t = 1.5 s/5 s
Direct voltage variations	IEC/EN 61131-2; IEC 61000-4-29; IACS E10 (PLC not connected to charging battery)	0.85...1.2 Un + ripple: 5 % peak; 2 steps t = 30 min
Third Harmonic	IEC/EN 61131-2	H3 (10 % Un) , 0 ° / 180 °; 2 steps t = 5 min
Immunity to conducted low frequency (only IACS)	IACS E10	For ~ : ■ H2...H15 (10 % Un), H15...H100 (10 %...1 % Un), H100...H200 (1 % Un) For --- : ■ H2...H200 (10 % Un)
Voltage interruptions	IEC/EN 61131-2; IEC/EN 61000-6-2; IEC 61000-4-11; IEC 61000-4-29; IACS E10	Power supply immunity: ■ 1ms for c PS1 / 10ms for a/c PS2 ■ Check operating mode for longer interruptions For IACS: ■ 30 s for ~ or ---
	IEC/EN 61131-2; IEC/EN 61000-6-2; IEC 61000-4-11	For ~ PS2: ■ 20 % Un, t0: ½ period ■ 40 % Un, cycle 10/12 ■ 70 % Un, cycle: 25/30 ■ 0 % Un, cycle 250/300
Voltage shut-down and start-up	IEC/EN 61131-2	■ Un...0...Un; t = Un/60 s ■ Umin...0...Umin; t = Umin/5 s ■ Umin...0.9 Udl...Umin; t = Umin/60 s
Magnetic field	IEC/EN 61131-2; IEC/TS 61000-6-5; IEC 61000-4-8 (for MV power stations: IEC 61850-3) IEC 61000-4-10 (for MV power stations: IEC 61850-3)	Power frequency: 50/60 Hz, 100 A/m continuous ...1000 A/m; t = 3 s; 3 axes Oscillatory: 100 kHz...1 MHz , 100 A/m; t = 9 s; 3 axes
Conducted common mode disturbances range 0 Hz ...150 kHz	IEC 61000-4-16 (for MV power stations: IEC 61850-3)	For remote systems: ■ 50/60 Hz and ---, 300 V , t = 1 s ■ 50/60 Hz and ---, 30 V , t = 1 min ■ 5 Hz...150 kHz, sweep 3 V...30 V

Where:

- PS1 applies to PLC supplied by battery, PS2 applies to PLC energized from ~ or --- supplies
- Un: nominal voltage, Fn: nominal frequency, Udl: detection level when powered

Name of test	Standards	Levels
<b>Immunity to HF interference. (CC) (1) (2)</b>		
Electrostatic discharges	IEC/EN 61131-2; IEC/EN 61000-6-2; IEC 61000-4-2; IACS E10	6 kV contact; 8 kV air; 6 kV indirect contact
Radiated radio frequency electromagnetic field	IEC/EN 61131-2; IEC/EN 61000-6-2; IEC 61000-4-3; IACS E10	15 V/m , 80 MHz ... 3 GHz Sinus amplitude modulated 80 % , 1 kHz + internal clock frequencies
Electrical fast transient bursts	IEC/EN 61131-2; IEC/EN 61000-6-2; IEC 61000-4-4; IACS E10	For ~ or --- main supplies: ■ 2 kV in common mode / 2 kV in wire mode For ~ or --- auxiliary supplies, ~ unshielded I/Os: ■ 2 kV in common mode For analog, --- unshielded I/Os, communication and all shielded lines: ■ 1 kV in common mode
Surge	IEC/EN 61131-2; IEC/EN 61000-6-2; IEC 61000-4-5; IACS E10	For ~ / --- main and auxiliary supplies, ~ unshielded I/Os: ■ 2 kV in common mode / 1 kV in differential mode For analog, --- unshielded I/Os: ■ 0.5 kV in common mode / 0.5 kV in differential mode For communication and all shielded lines: ■ 1 kV in common mode
Conducted disturbances induced by radiated electromagnetic fields	IEC/EN 61131-2; IEC/EN 61000-6-2; IEC 61000-4-6; IACS E10	10 V; 0,15 MHz...80 MHz Sinus amplitude 80%, 1 kHz + spot frequencies
Damped oscillatory wave	IEC/EN 61131-2; IEC 61000-4-18; IACS E10	For ~ / --- main supplies and ~ auxiliary supplies, ~ unshielded I/Os: ■ 2.5 kV in common mode / 1 kV in differential mode For --- auxiliary supplies, analog, --- unshielded I/Os: ■ 1 kV in common mode / 0.5 kV in differential mode For communication and all shielded lines: ■ 0.5 kV in common mode

(1) Devices must be installed, wired and maintained in compliance with the instructions provided in the manual "Grounding and Electromagnetic Compatibility of PLC Systems". standards.

(2) These tests are performed without a cabinet, with devices fixed on a metal grid and wired as per the recommendations in the manual "Grounding and Electromagnetic Compatibility of PLC systems".

(CC): tests required by European directives CC and based on IEC/EN 61131-2.

4

Environment tests (continued)		
Name of test	Standards	Levels
<b>Electromagnetic emissions (CE) (1)</b>		
Conducted emission	IEC/EN 61131-2; FCC part 15; IEC/EN 61000-6-4; CISPR 11 & 22, Class A, Group 1	150 kHz ... 500 kHz : quasi-peak 79 dB (µV/m); average 66 dB (µV/m) 500 kHz ... 30 MHz : quasi-peak 73 dB (µV/m); average 60 dB (µV/m)
	IACS E10	<ul style="list-style-type: none"> <li>■ ~ / ∞ power (general power distribution zone): 10 kHz ... 150 kHz : quasi-peak 120...69 dB (µV/m); 150 kHz ... 0.5 MHz : quasi-peak 79 dB (µV/m) 0.5 MHz ... 30 MHz : quasi-peak 73 dB (µV/m)</li> <li>■ ~ / ∞ power (bridge and deck zone for evaluation): 10 kHz ... 150 kHz : quasi-peak 96...50 dB (µV/m) 150 kHz ... 0,35 MHz : quasi-peak 60...50 dB (µV/m) 0.35 MHz ... 30 MHz : quasi-peak 50 dB (µV/m)</li> </ul>
Radiated emission	IEC/EN 61131-2; FCC part 15; IEC/EN 61000-6-4; CISPR 11 & 22, Class A, Group 1	30 MHz ... 230 MHz : quasi-peak 40 dB (µV/m) (at 10 m); 50 dB (µV/m) (at 3m) 230 MHz ... 1 GHz : quasi-peak 47 dB(µV/m) (at 10 m); 57 dB (µV/m) (at 3m)
	IACS E10	<ul style="list-style-type: none"> <li>■ For general power distribution zone 0.15 MHz ... 30 Mhz: quasi-peak 80...50 dB (µV/m) (at 3m) 30 MHz-100 MHz: quasi-peak 60...54 dB (µV/m) (at 3m) 100 MHz - 2 GHz: quasi-peak 54 dB (µV/m) (at 3m) 156 ... 165 MHz: quasi-peak 24 dB (µV /m) (at 3m)</li> </ul>
<b>Immunity to climatic variations (1) (power on)</b>		
Dry heat	IEC 60068-2-2 (Bb & Bd)	60 °C , t = 16 h [for ruggedized range: 70 °C , t = 16 h] (2)
	IACS E10	60 °C , t = 16 h + 70 °C , t = 2 h [for ruggedized range: 70 °C , t = 18 h] (2)
Cold	IEC 60068-2-1 (Ab & Ad) IACS E10	0 °C ... - 25 °C , t = 16 h + power on at 0 °C [for ruggedized range: power on at -25 °C] (2)
Damp heat, steady state (continuous humidity)	IEC 60068-2-78 (Cab); IACS E10	55 °C , 93 % relative humidity , t = 96 h [for ruggedized range: 60 °C] (2)
Damp heat, cyclic (cyclical humidity)	IEC 60068-2-30 (Db); IACS E10	55 °C ... 25 °C , 93...95 % relative humidity , 2 cycles t = 12 h + 12 h
Change of temperature	IEC 60068-2-14 (Na & Nb)	0 °C ... 60 °C , 5 cycles t = 6 h + 6 h [for ruggedized range: - 25 ... 70 °C] (2)
<b>Withstand to climatic variations (1) (power off)</b>		
Dry heat	IEC/EN 61131-2; IEC 60068-2-2 (Bb & Bd) IEC/EN 60945	85 °C , t = 96 h
Cold	IEC/EN 61131-2; IEC 60068-2-1 (Ab & Ad); IACS E10	- 40 °C , t = 96 h
Damp heat, cyclic (cyclical humidity)	IEC/EN 61131-2; IEC 60068-2-30 (Db)	55 °C ... 25 °C , 93...95 % relative humidity , 2 cycles t = 12 h + 12 h
Change of temperature (thermal shocks)	IEC/EN 61131-2; IEC 60068-2-14 (Na & Nb)	- 40 °C ... 85 °C , 5 cycles t = 3 h + 3 h

(1) Devices must be installed, wired and maintained in compliance with the instructions provided in the manual "Grounding and Electromagnetic Compatibility of PLC Systems".

(2) Refer also to chapter "Treatment for severe environments".

(CE): tests required by European directives CE and based on IEC/EN 61131-2 standards.

Environment tests (continued)		
Name of test	Standards	Levels
<b>Immunity to mechanical constraints (1) (power on)</b>		
Sinusoidal vibrations	IEC/EN 61131-2; IEC 60068-2-6 (Fc)	Basic IEC/EN 61131-2: 5 Hz ... 150 Hz , ± 3.5 mm amplitude (5 Hz ... 8.4 Hz) , 1g (8.4 Hz ... 150 Hz) Specific profile: 5 Hz ... 150 Hz , ± 10.4 mm amplitude (5 Hz ... 8.4 Hz) , 3 g (8.4 Hz ... 150 Hz) For basic and specific, endurance: 10 sweep cycles for each axis
	IACS E10	3 Hz ... 100 Hz , 1 mm amplitude (3 Hz ... 13.2 Hz) , 0.7 g (13.2 Hz ... 100 Hz) Endurance at each resonance frequency : 90 min for each axis , amplification coefficient < 10
	IEC 60068-2-6	Sismic analysis: 3 Hz ... 35 Hz , 22.5 mm amplitude (3 Hz ... 8.1 Hz) , 6 g (8.1 Hz ... 35 Hz)
Shocks	IEC/EN 61131-2; IEC 60068-2-27 (Ea)	30 g , 11 ms; 3 shocks/direction/axis (2) 25 g , 6 ms; 100 bumps/direction/axis (bumps) (3)
Free fall during operation	IEC/EN 61131-2; IEC 60068-2-32 (Ed Method 1)	1 m , 2 falls
<b>Withstand to mechanical constraints (power off)</b>		
Random free fall with packaging	IEC/EN 61131-2; IEC 60068-2-32 (Method 1)	1 m , 5 falls
Flat free fall	IEC/EN 61131-2; IEC 60068-2-32 (Ed Method 1)	10 cm , 2 falls
Controlled free fall	IEC/EN 61131-2; IEC 60068-2-31 (Ec)	30 ° or 10 cm , 2 falls
Plugging / Unplugging	IEC/EN 61131-2	For modules and connectors: Operations: 50 for permanent connections , 500 for non-permanent connections
<b>Equipment and personnel safety (1) (CE)</b>		
Dielectric strength and insulation resistance	IEC/EN 61131-2; IEC 61010-2-201; UL; CSA	Dielectric: 2 Un + 1000 V; t = 1 min Insulation: Un ≤ 50 V: 10 MΩ , 50 V ≤ Un ≤ 250 V : 100 MΩ
Continuity of earth	IEC/EN 61131-2; IEC 61010-2-201; UL; CSA	30 A , R ≤ 0,1Ω; t = 2min
Leakage current	UL; CSA	≤ 3.5 mA after disconnecting
Protection offered by enclosures	IEC/EN 61131-2; IEC 61010-2-201;	IP20 and protection against standardized pins
Impact withstand	IEC/EN 61131-2; IEC 61010-2-201; UL; CSA	Sphere of 500 g, fall from 1.30 m (energy 6.8 J minimum)
Stored energy injury risk	IEC/EN 61131-2; IEC 61010-2-201	Non permanent connection: 37 % Un after 1 s Permanent connection: 37 % Un after 10 s
Overload	IEC/EN 61131-2; IEC 61010-2-201; UL; CSA	50 cycles, Un, 1.5 In; t = 1 s ON + 9 s OFF
Endurance	IEC/EN 61131-2; IEC 61010-2-201; UL; CSA	In, Un; 12 cycles: t=100 ms ON + 100 ms OFF, 988 cycles : t = 1 s ON + 1 s OFF, 5000 cycles : t = 1 s ON + 9 s OFF
Temperature rise	IEC/EN 61131-2; UL; CSA; ATEX; IECEx	Ambient temperature 60 °C [for ruggedized range: 70 °C] (4)
<b>Specific Environment (1)</b>		
Corrosion areas - gas, salt, dust	ISAS 71.4	Mixed flowing gases: class G3 , 25 °C , 75 % relative humidity, t = 14 days (4)
	IEC 60721-3-3	Mixed flowing gases: class 3C3 , 25 °C , 75 % relative humidity, t = 14 days (4)
	IEC 60068-2-52	Salt spray: test Kb , severity 2 (4)

(1) Devices must be installed, wired and maintained in compliance with the instructions provided in the manual "Grounding and Electromagnetic Compatibility of PLC Systems".

(2) In case of using fast actuators (response time ≤ 5 ms) driven by relay outputs: 15 g , 11 ms; 3 shocks/direction/axis.

(3) In case of using fast actuators (response time ≤ 15 ms) driven by relay outputs: 15 g , 6 ms; 100 bumps/direction/axis.

(4) Refer also to chapter "Treatment for severe environments".

(CE): tests required by European directives CE and based on IEC/EN 61131-2 standards.

### Presentation

The ConneXium Industrial Ethernet offer comprises a complete family of products and tools (including the ConneXium Network Manager (CNM) software tool) required to build the infrastructure of an Industrial Ethernet network. The following pages provide information on network design and component selection.

### Office Ethernet versus Industrial Ethernet

There are three main areas of differentiation between Ethernet applications in an office environment and those in an industrial environment:

- Environment
- Layout (not physical layer specification)
- Performance

Contrary to the office environment and even though ISO/IEC is working on it, as yet there are no clearly defined specifications for Ethernet devices intended for industrial applications. The specifications of what it is called Industrial Ethernet are defined by different agencies or entities based upon its nature and what the automation market has traditionally used.

The environmental specifications of Industrial Ethernet devices are defined by the traditional agencies that define the environmental specifications for standard industrial devices (UL, CSA, CE, etc.).

IEEE 802.3 defines the physical layer specifications of the Ethernet network (types of connector, distance between devices, number of devices, etc.) while standard 11801 (similar to TIA/EIA 568B and CENELEC EN 50173) provides layout guidelines for installers.

The performance specifications are currently being drawn up by ISO/IEC.

### Ethernet 802.3 principles

The Ethernet 802.3 Link Layer is based on a collision detection mechanism (CSMA CD) whereby every node whose information has collided on the network detects the collision and re-sends the information.

The process of re-sending information causes delays in its propagation and could affect the application.

A collision domain is a group of Ethernet end devices interconnected by hubs or repeaters (devices that receive information and send it out to all their other ports, no matter where the destination device is connected). This means that all devices will be affected by collisions.

With full duplex switches (devices that receive information and only send it out through the port to which the destination device is connected), there are no collision domains.

Therefore, for industrial automation applications it is highly advisable to use full duplex switches to interconnect devices. This will help eliminate collision domains.

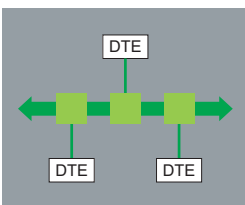
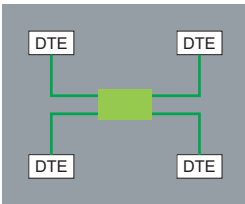

### Different network topologies

#### Star topology

In a star topology, all devices and Data Terminal Equipment (DTE) are connected through an intermediate device.

#### Ethernet star

In an Ethernet star the intermediate device may be a **switch**. The star is the most commonly used topology in corporate networks and is currently adopted in almost every automation application. As mentioned previously, for industrial Ethernet applications the use of full duplex switches as the central device rather than hubs is highly recommended.

#### Deploying star topologies with ConneXium

Star topologies can be implemented with any of the switches in the ConneXium offer.

#### Bus topology

The bus is one of the most common topologies in traditional industrial automation networks. A single trunk cable connects all devices on the network usually via passive or active T-connectors, or directly chained (daisy chain). Devices can usually be installed anywhere along the bus.

#### Ethernet bus

An Ethernet bus can be deployed by interconnecting **switches** in line and considering every one of them as the connection for a drop device. An unlimited number of switches can be interconnected to achieve this purpose.

#### Deploying bus topologies with ConneXium

Bus topologies can be implemented with any of the switches in the ConneXium offer. Switches with 1 or 2 fiber optic ports are particularly suitable for this purpose:

- Switches with 2 fiber optic ports can be used to connect in-line devices.
- Switches with 1 fiber optic port can be used to connect end-of-line devices.

#### Daisy chain topology

Daisy chain - along the bus - is the other most common topology in traditional industrial automation networks. Cable segments interconnect multiple devices, being the devices "part" of the network cable.

#### Ethernet daisy chain

Daisy chain is currently not a particularly common Ethernet topology, but it is likely to rise in popularity as more devices become available.

Ethernet daisy chain devices have:

- **2 Ethernet ports** and
- **1 embedded switch**.

Schneider Electric is launching Industrial Ethernet devices on the industrial market for connection in daisy chain architectures.

#### Deploying daisy chain topologies

No switches are required for daisy chain topologies. All devices have an embedded switch.

Dual port Ethernet at device level is an absolute integral component for daisy chain topologies.

One port on the device connects to one port on each of the two neighboring devices. These neighboring connections make up the daisy chain.

Ethernet switches can be employed in a daisy chain topology when multiple scan chains are in use by the controlling device. It is expected that the Ethernet switch will be located near the controlling device with the different scan chains emanating from the switch.



### Different network topologies (continued)

#### Daisy chain topology (continued)

##### Limitations of the daisy chain:

Limitations of the daisy chain topology in terms of operational integrity of the network and performance metrics are as follows:

- Dual port Ethernet devices only support 10 Mbps and/or 100 Mbps operational speeds and must use one or the other.
- The network will operate only as fast as the slowest device that is connected to the network.
- In order to improve network traffic latency, the number of devices in a single scan chain is limited to 32 devices. This means that the time for a round trip of a packet through the daisy chain is likely to be less than 5 milliseconds.

The maximum latency of a packet passing through any device in a scan chain is no more than 10  $\mu$ s.

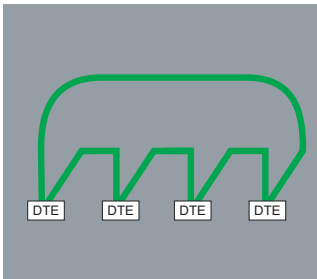
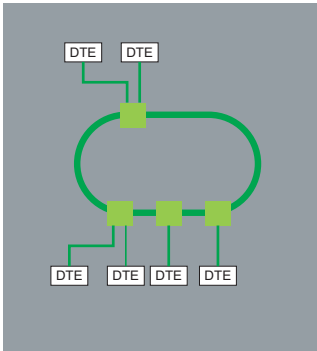

#### Ring topology

In a ring topology, all devices or network infrastructure components are connected in a loop. Through this type of topology, a type of network redundancy is achieved.

Ring topologies also help improve the availability of the network and its communication to devices.

##### Ethernet ring

Ethernet rings are usually the backbones of applications in which high availability is required. If ring topology is required then switches that support this feature should be ordered.

##### Deploying ring topologies using ConneXium

ConneXium offers switches that allow the deployment of single and coupled self-healing rings.

##### Daisy chain loop

A daisy chain loop consists of several daisy chain devices that are placed in a ring topology.

When an Ethernet network forms a loop, all the devices in that loop must use the same protocol (RSTP, MRP, or HIPER-Ring).

### Distance limitations and number of devices per segment

Based on standard 802.3, the distance limits and number of devices in cascade are as follows:

Type	Maximum segment length (1)	Maximum segment length (offered by ConneXium devices)	Maximum number of hubs in cascade	Maximum number of switches in cascade
10BASE-T	100 m/328.08 ft	100 m/328.08 ft	4	Unlimited
100BASE-TX	100 m/328.08 ft	100 m/328.08 ft	2	Unlimited
1000BASE-T	100 m/328.08 ft	100 m/328.08 ft	–	Unlimited
10BASE-FL	2,000 m/6,561.66 ft	3,100 m/10,170.57 ft (2)	11 (fiber ring)	–
100BASE-FX	412 m/1,351.70 ft 2,000 m/6,561.66 ft	4,000 m/13,123.32 ft with multimode fiber, 32,500 m/106,627 ft with singlemode fiber (3)	–	Unlimited
1000BASE-SX	275 m/902.23 ft	–	–	Unlimited

(1) Based on 802.3, full duplex/half duplex.

(2) Depends on the optical fiber budget and fiber attenuation.

(3) Depends on the optical fiber budget and fiber attenuation, typical specification is 2,000 m/6,561.66 ft for multimode and 15,000 m/49,212.45 ft for singlemode.

### Physical media

The Ethernet 802.3 standard defines the Physical Layer. A summary of the most common media is given below:

Type	Data rate	Cable type		Connector type	
		Defined by 802.3	Recommended by Schneider Electric	Defined by 802.3	Recommended by Schneider Electric
10BASE-T	10 Mbps	CAT 3 - UTP	CAT 5E - STP	RJ45	RJ45
100BASE-TX	100 Mbps	CAT 5 - UTP	CAT 5E - STP	RJ45	RJ45
1000BASE-T	1 Gbps	CAT 5 - UTP	CAT 5E - STP	RJ45	RJ45
10BASE-FL	10 Mbps	Two multimode optical fiber cables typically 62.5/125 µm fiber, 850 nm light wavelength	Two multimode optical fiber cables typically 62.5/125 µm fiber, 850 nm light wavelength	ST	ST
100BASE-FX	100 Mbps	Two multimode optical fibers typically 62.5/125 µm multimode fiber, 1,300 nm light wavelength	Two multimode optical fibers typically 62.5/125 µm multimode fiber, 1,300 nm light wavelength	ST	SC
		–	Two monomode optical fibers typically 9/125 µm multimode fiber, 1,300 nm light wavelength	–	SC
1000BASE-SX	1 Gbps	Two 62.5/125 or 50/125 multimode optical fibers, 770 to 860 nm light wavelength	Two 62.5/125 µm or 50/125 m multimode optical fibers, 1,300 nm light wavelength	SC	LC
1000BASE-LX	1 Gbps	–	Two 9/125 µm singlemode optical fibers, 1,300 nm light wavelength	–	LC

**Note:** These specifications are defined by IEEE 802.3. However, some of the cables are no longer being developed. For instance, for 10BASE-T and 100BASE-TX, a CAT-5E cable is used.

### Management

Ethernet devices in general (end-of-line devices and cabling devices) can be divided into two categories: unmanaged and managed devices.

- **Unmanaged** devices are those devices for which there is no option to configure or control any of the device parameters.
- **Managed** devices are those devices whose parameters can be configured or controlled (managed) and their internal data can be accessed.

The ConneXium product line offers both types of device.

There is also a third, unspecified category of device, which is normally classed as a managed device. However, there is one major difference: although this device allows access to its internal data, it cannot be controlled and/or configured.

### Managed devices

Managed devices offer the following features:

- **Traffic optimization and filtering** - The aim is to increase the bandwidth, or the traffic capacity in a network (some of the features in this area are message and port priority, flow control, multicast filtering, broadcast limiting, IGMP snooping, Vlan, etc.).
- **VLAN** - A virtual LAN (VLAN) consists of a group of network participants in one or more network segments who can communicate with each other as if they belonged to the same LAN.

VLANs are based on logical (instead of physical) links. The biggest advantage of VLANs is their possibility of forming user groups based on the participant function and not on their physical location or medium.

Since broad/multicast data packets are transmitted exclusively within a virtual LAN, the remaining data network is unaffected. VLAN can also serve as a security mechanism to block unwanted Unicast messages.

- **Security** - This feature helps the user protect the switch from unauthorized access that could result in changes in its configuration and impact the traffic going through the switch (some of the features in this area are port security, read/write community name, etc.).

Users can also set up the switch so that it blocks messages coming from unauthorized "device" source addresses connected to the switch.

- **Time synchronization** - This feature allows all devices in a network to be synchronized according to the time.
- **Network redundancy** - This helps to develop high availability applications.
- **Dual ring switch (DRS)** - These switches are provided with predefined settings to optimize communication performance and help save time in Ethernet RIO architectures with Modicon Quantum and Modicon M580 automation platforms. DRS switches are mandatory to build Ethernet RIO architectures in which sub-rings have to be connected to the main Ethernet ring.

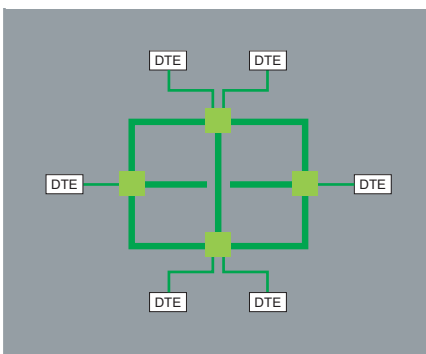
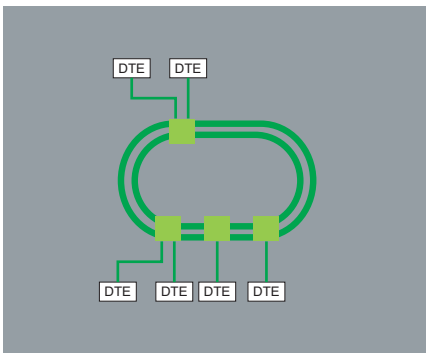
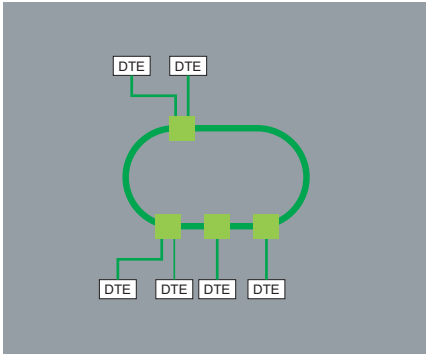

### Redundancy

To develop high availability applications, “redundancy” in the networking infrastructure is the answer. Developers can help avoid losing network segments by implementing a single ring or a coupled ring architecture.

#### Single ring

The first level of redundancy is achieved by implementing a single ring. ConneXium switches allow the set up of backbone ring configurations.

ConneXium switches support three redundancy protocols: HIPER-Ring, MRP, and RSTP.

The ring is constructed using HIPER-Ring ports. If an error is detected in one section of the line, a ring structure of up to 50 switches transforms back to a line-type configuration within 0.5 seconds.

With a Modicon Quantum or a Modicon M580 Ethernet RIO architecture, the recovery loop can be optimized to less than 50 ms thanks to the RSTP protocol implemented in the different devices.

#### Dual ring

The second level of redundancy is achieved by implementing a dual ring. The control intelligence built into ConneXium switches allows the redundant coupling of HIPER-Rings and network segments.

As for a single ring, the recovery time can be optimized to less than 50 ms for 16 switches or 32 RIO drop adapters thanks to the RSTP protocol.

#### Mesh topology using the rapid “Spanning Tree” protocol

A third level of redundancy can be achieved by implementing a mesh topology. In simple terms, “Spanning Tree” is a protocol that provides a single path for the signal, when multiple paths exist. If the active path is broken, the “Spanning Tree” protocol enables one of the alternative paths.

ConneXium switches offer this possibility.

#### Security

ConneXium firewalls help improve security for industrial networks while meeting the needs for cybersecurity.

Firewall rules can be defined to control access levels at the host, protocol, and port levels.

Further rules can be defined for other purposes, such as protecting access to Modbus/TCP function codes and register levels, or EtherNet/IP CIP objects and service codes.

ConneXium firewalls can also offer layer 3 routing, network address translation (NAT), and virtual private networks (VPN) for advanced security zoning of critical industrial networks.

# Technical appendices

## Automation product certifications

### EC regulations

Some countries require certain electrical components to undergo certification by law. This certification takes the form of a certificate of conformity to the relevant standards and is issued by the official body in question. Where applicable, certified devices must be labelled accordingly. Use of electrical equipment on board merchant vessels generally implies that it has gained prior approval (i.e. certification) by certain shipping classification societies.

Abbreviation	Certification body	Country
<b>CSA</b>	Canadian Standards Association	Canada
<b>RCM</b> (formerly C-Tick)	Australian Communications and Media Authority	Australia, New Zealand
<b>EAC</b> (formerly GOST)	Eurasian conformity	Russia and customs union
<b>UL</b>	Underwriters Laboratories	USA









  

Abbreviation	Classification authority	Country
<b>IACS</b>	International Association of Classification Societies	International
<b>ABS</b>	American Bureau of Shipping	USA
<b>BV</b>	Bureau Veritas	France
<b>DNV</b>	Det Norske Veritas	Norway
<b>GL</b>	Germanischer Lloyd	Germany
<b>LR</b>	Lloyd's Register	UK
<b>RINA</b>	Registro Italiano Navale	Italy
<b>RMRS</b>	Russian Maritime Register of Shipping	Russia
<b>RRR</b>	Russian River Register	Russia
<b>CCS</b>	China Classification Society	China

The tables below provide an overview of the situation as at 9th January 2014 in terms of which certifications (listed next to their respective bodies) have been granted or are pending for our automation products.

Up-to-date information on which certifications have been obtained by products bearing the Schneider Electric brand can be viewed on our website: [www.schneider-electric.com](http://www.schneider-electric.com)

### Product certifications

Certified Certification pending	Certifications						
	 UL USA	 CSA Canada	 RCM Australia	 EAC (9) Russia	Hazardous locations (1) Class I, div 2 USA, Canada	   (6)	 TÜV Rheinland Functional Safety Type-Approved FS
Modicon OTB							
Modicon STB					FM	Zone 2 (2)(5)	
Modicon Telefast ABE 7							
ConneXium					(2)		
Magelis iPC/GTW		(3)		(2)	(3)	Zone 2/22 (2)	
Magelis XBT GT		(3)		(2)	(2) (3)	Zone 2/22 (2)(5)	
Magelis XBT GK		(3)			(3)		
Magelis XBT N/R/RT					CSA	Zone 2/22 (2)(5)	
Magelis HMI GTO		(3)		(2)	(3)	(2)	
Magelis HMI STO/STU		(3)		(2)	(2)(3)	(2)	
Modicon M340					CSA	Zone 2/22 (2)(8)	
Modicon M580							
Modicon X80 I/O					CSA	Zone 2/22 (2)(8)	
Modicon Momentum					FM		
Modicon Premium				(2)	CSA		
Modicon Quantum				(2)	CSA, FM (2)	Zone 2/22 (2)	
Modicon Quantum Safety				(2)	CSA	Zone 2/22 (2)	SIL 2, SIL 3 (7)
Preventa XPSMF							SIL 3 (7)
Modicon TSX Micro					CSA		
Phaseo	(3)						
Twido	(4)	(4)			CSA/UL (4)		

(1) Hazardous locations: According to ANSI/ISA 12.12.01, CSA 22.2 No. 213 and FM 3611, certified products are only approved for use in hazardous locations categorized as Class I, division 2, groups A, B, C and D, or in non-classified locations.

(2) Depends on product; please visit our website: [www.schneider-electric.com](http://www.schneider-electric.com).

(3) North American certification cULus (Canada and USA).

(4) Except for AS-Interface module TWD NOI 10M3, CE only.

(5) For zones not covered by this specification, Schneider Electric offers a solution as part of the CAPP (Collaborative Automation Partner Program). Please consult our Customer Care Centre.

(6) Refer to the instructions supplied with each ATEX and/or IECEx certified product.

(7) According to IEC 61508. Certified by TÜV Rheinland for integration into a safety function of up to SIL 2 or SIL 3.

(8) Can be used in gassy mines under certain conditions.











(9) Formerly GOST. GOST will be replaced by EAC after certificates are renewed.

# Technical appendices

## Automation product certifications

### EC regulations

#### Merchant navy certifications

Certified Certification pending	Shipping classification societies										
											
	ABS	BV	DNV	GL	KRS	LR	RINA	RMRS	RRR	PRS	CCS
	USA	France	Norway	Germany	Korea	Great Britain	Italy	Russia	Russia	Poland	China
Modicon OTB											
Modicon STB	(1) (2)	(2)	(2)	(2)		(2)	(2)				
Modicon Telefast ABE 7											
ConneXium											
Magelis iPC/GTW				Bridge (2)							
Magelis XBT GT	(2)	(2)	(2)	(2)		(2)	(2)	(2)	(2)		
Magelis XBT GK											
Magelis XBT N/R											
Magelis XBT RT											
Magelis HMI GTO											
Magelis HMI STO/STU		(2)	(2)								
Modicon M340								(2)	(2)		
Modicon M580											
Modicon X80 I/O								(2)	(2)		
Modicon Momentum											
Modicon Premium											
Modicon Quantum											
Modicon TSX Micro											
Phaseo											
Twido											

(1) Also covers US Navy requirements **ABS-NRV** part 4.

(2) Depends on product; please visit our website: [www.schneider-electric.com](http://www.schneider-electric.com).

#### EC regulations

##### European Directives

The open nature of the European markets assumes harmonization between the regulations set by the member states of the European Union. European Directives are texts whose aim is to remove restrictions on free circulation of goods and which must be applied within all European Union states.

Member states are obligated to incorporate each Directive into their national legislation, and to simultaneously withdraw any regulations that contradict it.

Directives - and particularly those of a technical nature with which we are concerned - merely set out the objectives to be fulfilled (referred to as "essential requirements"). Manufacturers are responsible for taking the necessary measures to establish that their products conform to the requirements of each Directive applicable to their equipment.

As a general rule, manufacturers certify compliance with the essential requirements of the Directive(s) that apply to their products by applying a CE mark. The CE mark is affixed to our products where applicable.

##### Significance of the CE mark

The CE mark on a product indicates the manufacturer's certification that the product conforms to the relevant European Directives; this is a prerequisite for placing a product which is subject to the requirements of one or more Directives on the market and allowing its free circulation within European Union countries. The CE mark is intended for use by those responsible for regulating national markets.

Where electrical equipment is concerned, conformity to standards indicates that the product is fit for use. Only a warranty by a well-known manufacturer can provide reassurance of a high level of quality.

As far as our products are concerned, one or more Directives are likely to apply in each case; in particular:

- The Low Voltage Directive (2006/95/EC)
- The Electromagnetic Compatibility Directive (2004/108/EC)
- The ATEX CE Directive (94/9/EC)

##### Hazardous substances

These products are compatible with:

- The WEEE Directive (2002/96/EC)
- The RoHS Directive ((2011/65/EU)
- The China RoHS Directive (Standard SJ/T 11363-2006)
- The REACH regulations Directive (EC 1907/2006)

**Note:** Documentation on sustainable development is available on our website [www.schneider-electric.com](http://www.schneider-electric.com) (product environmental profiles and instructions for use, ROHS and REACH directives).

##### End of life (WEEE)

End of life products containing electronic cards must be dealt with by specific treatment processes.

When products containing backup batteries are unusable or at end of life they must be collected and treated separately. Batteries do not contain a percentage by weight of heavy metals above the limit specified by European Directive 2006/66/EC.

### Presentation

The power required to supply each **BMXXBP●●00** rack depends on the type and number of modules installed in the racks. It is therefore necessary to draw up a power consumption table rack by rack in order to determine the **BMXCPS●●●●●** power supply module most suitable for each rack.

The calculation sheet on the page opposite can be used to calculate the power consumption of the 2 or 3 voltages provided (depending on the model) by the **BMXCPS●●●●●** power supply module: 3.3 V  $\overline{\text{---}}$ , 24 V  $\overline{\text{---}}$  (rack) and 24 V  $\overline{\text{---}}$  (sensors).

### Method

- Check and select a power supply module corresponding to the power available on the 2 or 3 voltages.
- Check that the sum of the absorbed power on these three voltages does not exceed the total power of the power supply module.
- Values to be entered depending on the Modicon M340 PLC configuration.

# Choice of BMXCPS power supplies

Photocopy this document or use the M340 Design software, available on our website: [www.schneider-electric.com](http://www.schneider-electric.com)

# Modicon M340 automation platform

## Power consumption table Calculation sheet

Rack no. 0 - 1 - 2 - 3	Module reference	Format S : Standard D : Double	Number	Consumption in mA (1)												
				3.3 V $\bar{\text{v}}$ voltage		24 V $\bar{\text{v}}$ rack voltage		24 V $\bar{\text{v}}$ sensor voltage								
				Module	Total	Module	Total	Module	Total							
<b>Rack</b>	<b>BMXXBP0400(H)</b>	-		304												
	<b>BMXXBP0600(H)</b>	-		455												
	<b>BMXXBP0800(H)</b>	-		607												
	<b>BMXXBP1200H</b>	-		225												
<b>Processor (rack 0)</b>	<b>BMXP341000(H)</b>	S				72										
	<b>BMXP342000</b>	S				72										
	<b>BMXP342010/20102</b>	S				90										
	<b>BMXP342020(H)</b>	S				95										
	<b>BMXP342030/20302H</b>	S				135										
<b>Rack expansion (rack 0, 1, 2 or 3)</b>	<b>BMXXBE1000</b>	-		22		160										
<b>Discrete I/O</b>	<b>BMXDAI0805</b>	S		76		13										
	<b>BMXDAI1602(H)</b>	S		90		60										
	<b>BMXDAI1603(H)</b>	S		90		60										
	<b>BMXDAI1604(H)</b>	S		90		60										
	<b>BMXDAO1605(H)</b>	S		100		95										
	<b>BMXDDI1602(H)</b>	S		90												
	<b>BMXDDI1603(H)</b>	S		90												
	<b>BMXDDI1604T</b>	S		76												
	<b>BMXDDI3202K</b>	S		140					110							
	<b>BMXDDI6402K</b>	S		200					110							
	<b>BMXDDM16022(H)</b>	S		100					30							
	<b>BMXDDM16025(H)</b>	S		100		50			30							
	<b>BMXDDM3202K</b>	S		150					55							
	<b>BMXDDO1602(H)</b>	S		100												
	<b>BMXDDO1612(H)</b>	S		100												
	<b>BMXDDO3202K</b>	S		150												
	<b>BMXDDO6402K</b>	S		240												
	<b>BMXDRA0804T</b>	S		61		104										
	<b>BMXDRA0805(H)</b>	S		100		55										
	<b>BMXDRA1605(H)</b>	S		100		95										
<b>Analog I/O</b>	<b>BMXAMI0410(H)</b>	S		150		45										
	<b>BMXAMI0800</b>	S		150		30										
	<b>BMXAMI0810 (H)</b>	S		150		45										
	<b>BMXAMM0600(H)</b>	S		150		130										
	<b>BMXAMO0210(H)</b>	S		150		110										
	<b>BMXAMO0410(H)</b>	S		150		84										
	<b>BMXAMO0802</b>	S		150		74										
	<b>BMXART0414(H)</b>	S		150		40										
	<b>BMXART0814(H)</b>	S		150		100										
<b>Counting</b>	<b>BMXEHC0200(H)</b>	S		200		40		80								
	<b>BMXEHC0800(H)</b>	S		200				80								
<b>SSI encoder interface</b>	<b>BMXEAE0300(H)</b>	S		150												
<b>Motion control</b>	<b>BMXMSP0200</b>	S		200		150										
<b>Communication</b>	<b>BMXEIA0100</b>	S		160												
	<b>BMXNOE0100(H)</b>	S				90										
	<b>BMXNOE0110(H)</b>	S				90										
	<b>BMXNOM0200(H)</b>	S				80										
	<b>BMXNOC0401</b>	S		555												
	<b>BMXNOR0200H</b>	S				95										
<b>Power consumption</b>			Courant total (mA)	<input type="text" value=""/>	x 3,3 V	<input type="text" value=""/>	+	<input type="text" value=""/>	x 24 V	<input type="text" value=""/>	+	<input type="text" value=""/>	x 24 V	<input type="text" value=""/>	=	<input type="text" value=""/>
			Puissance consommée (mW)	<input type="text" value=""/>		<input type="text" value=""/>		<input type="text" value=""/>		<input type="text" value=""/>		<input type="text" value=""/>		<input type="text" value=""/>		<input type="text" value=""/>
				Available power (mW)				Total power (mW)								
<b>Choice of power supply module</b>	<b>BMXCPS2010</b>	D	24 V $\bar{\text{v}}$ isolated	<input type="text" value=""/>	<b>8250</b>	<input type="text" value=""/>	<input type="text" value=""/>	<input type="text" value=""/>	<b>16 800</b>	<input type="text" value=""/>	<input type="text" value=""/>	<input type="text" value=""/>	<input type="text" value=""/>	<b>17 000</b>		
	<b>BMXCPS3020 (H)</b>	D	24...48 V $\bar{\text{v}}$ isolated	<input type="text" value=""/>	<b>14850</b>	<input type="text" value=""/>	<input type="text" value=""/>	<input type="text" value=""/>	<b>31 200</b>	<input type="text" value=""/>	<input type="text" value=""/>	<input type="text" value=""/>	<input type="text" value=""/>	<b>32 000</b>		
	<b>BMXCPS2000</b>	D	100...240 V $\bar{\text{v}}$	<input type="text" value=""/>	<b>8250</b>	<input type="text" value=""/>	<input type="text" value=""/>	<input type="text" value=""/>	<b>16 800</b>	<input type="text" value=""/>	<input type="text" value=""/>	<input type="text" value=""/>	<b>10 800</b>	<b>20 000</b>		
	<b>BMXCPS3500 (H)</b>	D		<input type="text" value=""/>	<b>14850</b>	<input type="text" value=""/>	<input type="text" value=""/>	<input type="text" value=""/>	<b>31 200</b>	<input type="text" value=""/>	<input type="text" value=""/>	<input type="text" value=""/>	<b>21 600</b>	<b>36 000</b>		
	<b>BMXCPS3540T</b>	D	125 V $\bar{\text{v}}$	<input type="text" value=""/>	<b>14850</b>	<input type="text" value=""/>	<input type="text" value=""/>	<input type="text" value=""/>	<b>31 200</b>	<input type="text" value=""/>	<input type="text" value=""/>	<input type="text" value=""/>	<b>21 600</b>	<b>36 000</b>		

(1) Typical value given for 100% of inputs or outputs at state 1.





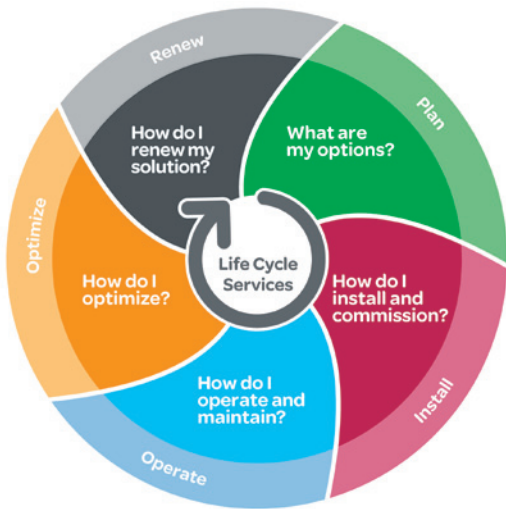

Schneider Electric, with its experts, products and dedicated tools, provides services such as system design, consultancy, maintenance contracts, modernisation of facilities or delivering projects.

The Schneider Electric services offer is structured around several key areas:

- Maintenance and support services:
  - A set of services to help maintain reliability and availability of automated control systems. These services may be the subject of a bespoke maintenance contract to meet your requirements more closely.
- Consultancy services:
  - Diagnostics of the installed base
- Modernization solutions:
  - Migration solutions including consultancy, expertise, tools and technical support to help ensure a smooth transition to newer technology while keeping the wiring and the encoding in most cases.

Customization services are also available to accommodate specific requirements. For more information, please consult the specific pages on our website [www.schneider-electric.com/automationservices](http://www.schneider-electric.com/automationservices)

## Maintenance and support services

### Spare parts, exchanges and repairs

#### *Everything you need to get equipment working again as quickly as possible*

Solutions to respond very quickly to requests for spare parts, exchanges and repairs to your installed automation equipment (automation platforms, Human Machine Interfaces, drives, distributed I/O):

- Spare parts management:
  - Identification of critical parts
  - Stock of spare parts: a Schneider Electric owned stock of spare parts, on your site or in one of our warehouses, with immediate availability on site or a contractually agreed delivery time if stored off site
  - Testing of spare parts stored on site
  - Automatic stock filling
- Repairs:
  - Broken down products are repaired in a network of worldwide repair centres. For each repaired product, our experts provide a detailed report.
- On-site repair:
  - Our experts' knowledge and expertise
  - Monitoring of specific repair procedures
  - Availability of our teams to respond 24/7
- Exchanges:
  - With standard replacements, receive a new or reconditioned product before the broken down product has even been sent back
  - Fast exchanges offer the option to receive the replacement product within 24 hours (in Europe)

### Preventive maintenance

#### *Improving and guaranteeing the long-term reliability and performance of your installations*

Schneider Electric's preventive maintenance expert assesses your site, the equipment to be managed and sets up a maintenance program to accommodate specific requirements. A list is provided of the tasks to be performed and their frequency, including site-specific tasks, describing how preventive maintenance is to be managed.

### Extended warranty

#### *An additional manufacturer warranty covering replacement or repair of the equipment*

The extended warranty offers the option to take out a 3-year warranty. The warranty period can vary according to the geographical area, consult your Customer Care Centre.

### Online support

#### *Access to dedicated experts*

Priority access to experts who can answer technical questions promptly concerning equipment and software both on sale and no longer commercially available.

### Software subscription

#### *Access to software upgrades and new features*

By subscribing to software updates, users are able to:

- Purchase licences
- Receive updates, upgrades, software migrations and transitions
- Download software from Schneider Electric's software library

## Consultancy services

### M2C (Maintenance and Modernization Consultancy)

*Professional tools and methods, proven experience of managing obsolescence and updating installed bases, to reduce downtimes and improve performance*

With our maintenance and modernization consultancy offer, Schneider Electric will help you check the state of your installed base by:

- Defining the scope and depth of the analysis in collaboration with you
- Collecting the technical data without shutting down production
- Analyzing and identifying avenues for improvement
- Producing a recommendation plan

Customer benefits:

- Learning about the components that make up the installed base and how up-to-date they are
- Better downtime anticipation
- Expert advice designed to improve performance

## Modernization solutions

### Migration to PlantStruxure

*Proven expertise, tools and methods to give you a clear vision of the improvement opportunities and guide you toward a successful modernization project*



To find out more about PlantStruxure architectures, please visit our website [www.schneider-electric.com/PlantStruxure](http://www.schneider-electric.com/PlantStruxure)

Schneider Electric offers a gradual program of modernization through a series of products, tools and services that allow you to upgrade to newer technology. There are several stages in this gradual modernization program:

- Partial program: replacement of an old component with a new one
- Staggered program: gradual incorporation of new offers in the system
- Total program: total renovation of the system

The table below lists our various migration offers:

### Wide range of migration offers

Solution		Change the CPU	Keep the I/O racks & wiring	Change the I/O racks & keep the wiring	Migrate your application	Manage your project	Execute your project
Platform (1)	TSX47 to TSX107	☑	☑	☑	☑	☑	☑
	April series 1000			☑	☑	☑	☑
	Modicon ●84, Compact	☑	☑	☑	☑	☑	☑
	April SMC				☑	☑	☑
	Merlin Gerin PB				☑	☑	☑
	AEG	☑	☑	☑	☑	☑	☑
	Symax	☑			☑	☑	☑
	Rockwell SLC500			☑	☑	☑	☑

☑

 Service available

(1) Our migration service offer also includes SCADA, Human Machine Interfaces, drives, communication networks and distributed I/O.

## Customization services

Schneider Electric is able to meet your specific requirements and provide you with adapted products:

- Protective coating for Human Machine Interfaces, automation platforms and distributed I/O modules for use in harsh environments
- Customized cable lengths to match your specific needs
- Customized front panels for Human Machine Interfaces

Note: To check availability of services required, please contact our Customer Care Centre.

<b>1</b>			
170DNT11000	2/29		
<b>4</b>			
490NAD91103	2/29		
490NAD91104	2/29		
490NAD91105	2/29		
<b>B</b>			
BMXNOC0401	2/23		
BMXNOE0100	2/21		
BMXNOE0100H	3/3		
BMXNOE0110	2/21		
BMXNOE0110H	3/3		
BMXP341000	1/13 2/39		
BMXP341000H	3/3		
BMXP342000	1/13 2/39		
BMXP342010	2/39		
BMXP342020	1/13 2/20 2/39		
BMXP342020H	3/3		
BMXP3420102	1/13 2/32 2/39		
BMXP3420102CL	1/13 2/32 2/39		
BMXP3420302	1/13 2/20 2/32		
BMXP3420302CL	1/13 2/20 2/32		
BMXP3420302H	3/3		
BMXRMS008MP	1/13 3/3		
BMXRMS008MPF	1/13 3/3		
BMXRMS128MPF	1/13 3/3		
BMXRWSB000M	2/21		
BMXRWSFC032M	2/21		
BMXXCAUSBH018	1/13 3/3		
BMXXCAUSBH045	1/13 3/3		
<b>F</b>			
FTXBLA10	2/37		
FTXC78B	2/37		
FTXC78F5	2/37		
FTXC78M5	2/37		
FTXCM08B	2/37		
FTXCM12B	2/37		
FTXCN12F5	2/34		
FTXCN12M5	2/34		
FTXCN3203	2/35		
FTXCN3206	2/35		
FTXCN3210	2/35		
FTXCN3220	2/35		
FTXCN3230	2/35		
FTXCN3250	2/35		
FTXCNCT1	2/36		
FTXCNTL12	2/36		
FTXCY1208	2/37		
FTXCY1212	2/37		
FTXDG12	2/37		
FTXDGP2115	2/36		
FTXDGP2130	2/36		
FTXDGP2150	2/36		
FTXDGP2206	2/36		
FTXDGP2210	2/36		
FTXDGP2220	2/36		
FTXDGP2250	2/36		
FTXMLA10	2/37		
<b>L</b>			
LU9GC3	2/40		
<b>S</b>			
SERM2MMOD485	2/41		
SERM2MUNI2	2/41		
STBNDP2212	2/29		
<b>T</b>			
TCSCCN4F3M1T	2/35		
TCSCCN4F3M3T	2/35		
TCSCCN4F3M05T	2/35		
TCSCCTN011M11F	2/36		
TCSEGDB23F24FA	2/27		
TCSEGDB23F24FK	2/27		
TCSEGA23F14F	2/29		
TCSEGA23F14FK	2/29 3/3		
TCSMCN3M4F3C2	2/41		
TCSMCN3M4M3S2	2/41 3/3		
TCSCCN3M4F3S4	3/3		
TLACDCBA005	2/35		
TLACDCBA015	2/35		
TLACDCBA030	2/35		
TLACDCBA050	2/35		
TSXCANCA50	2/34		
TSXCANCA100	2/34		
TSXCANCA300	2/34		
TSXCANCADD1	2/34		
TSXCANCADD03	2/34		
TSXCANCADD3	2/34		
TSXCANCADD5	2/34		
TSXCANCB50	2/34		
TSXCANCB100	2/34		
TSXCANCB300	2/34		
TSXCANCBDD1	2/34		
TSXCANCBDD03	2/34		
TSXCANCBDD3	2/34		
TSXCANCBDD5	2/34		
TSXCANCD50	2/34		
TSXCANCD100	2/34		
TSXCANCD300	2/34		
TSXCANKCDF90T	2/34		
TSXCANKCDF90TP	2/34		
TSXCANKCDF180T	2/34		
TSXCANTDM4	2/34		
TSXCSA100	2/41		
TSXCSA200	2/41		
TSXCSA500	2/41		
TSXPBSCA100	2/29		
TSXPBSCA400	2/29		
TSXSCA50	2/40		
TSXSCA62	2/40		
TSXS_PCM4530	2/41		
TWDXCAISO	2/40		
TWDXCARJ003	2/41		
TWDXCARJ010	2/41		
TWDXCARJ030	2/41		
TWDXCAT3RJ	2/40		
<b>V</b>			
VW3A8114	2/40		
VW3A8306	2/41		
VW3A8306D30	2/41		
VW3A8306R03	2/41		
VW3A8306R10	2/41		
VW3A8306R30	2/41		
VW3A8306RC	2/40		
VW3A8306TF03	2/40		
VW3A8306TF10	2/40		
VW3CANA71	2/36		
VW3CANCARR1	2/36		
VW3CANCARR03	2/36		
VW3CANKCDF180T	2/36		
VW3CANTAP2	2/34		
VW3M3805R010	2/35		
<b>X</b>			
XBTZ938	2/41		
XGSZ24	2/40		
XZCC12FCM50B	2/37		
XZCC12FDM50B	2/37		
XZCC12MCM50B	2/37		
XZCC12MDM50B	2/37		







**Schneider Electric Industries SAS**

[www.schneider-electric.com](http://www.schneider-electric.com)

Head Office  
35, rue Joseph Monier  
F-92500 Rueil-Malmaison  
France

The information provided in this documentation contains general descriptions and/or technical characteristics of the performance of the products contained herein. This documentation is not intended as a substitute for and is not to be used for determining suitability or reliability of these products for specific user applications. It is the duty of any such user or integrator to perform the appropriate and complete risk analysis, evaluation and testing of the products with respect to the relevant specific application or use thereof. Neither Schneider Electric nor any of its affiliates or subsidiaries shall be responsible or liable for misuse of the information contained herein.

Design: Schneider Electric  
Photos: Schneider Electric  
Printed by:

DIA6ED2110104EN

September 2014

